

Designed for your world

This operator's manual contains handling tips and precautions for safe operation of your TYM 3025 (CH) tractor. Read it carefully before you operate your tractor and make sure that you have a full understanding of this manual. This will ensure correct operation and to keep the tractor optimum condition.

After reading the manual, keep it close to the tractor for immediate reference. When you loan your tractor to someone else, loan the manual as well.

In case the manual is lost or damaged, please contact your local authorized dealer for a copy. Some parts of this product may have been changed for the improvement of quality or for safety reasons, in which case the photographs or drawings of the parts in this booklet may not be the same as the actual parts installed on this product. If you find anything in this manual unclear or need further explanation, please contact your authorized dealer.



※ Regarding the purpose of this machine

Do not modify the machine or try to do the job which is beyond purpose of this machine. Otherwise it may cause the warranty cancellation. (Refer to warranty statement for detail)

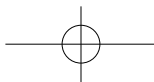
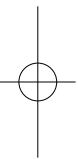
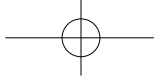

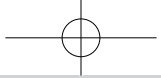

TABLE OF CONTENTS

SECTION





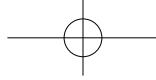

- FOR SAFE OPERATION 1
- REGARDING WARRANTY SUPPORT 2
- SPECIFICATIONS 3
- DESCRIPTION OF OPERATING SYSTEM 4
- OPERATION 5
- MAINTENANCE 6
- TROUBLESHOOTINGS 7
- STORAGE AND DISPOSAL 8
- EMISSIONS CONTROL WARRANTY 9

Designed for your world



SAFETY AND VEHICLE DAMAGE WARNING

This manual includes information titled as **DANGER, WARNING, CAUTION, IMPORTANT**. These safety marks stand for the safety precaution so follow the instruction with special attention:

 DANGER	<p>This symbol indicates that a condition may result in harm, fatal injury or death to you or other persons if this instruction is ignored.</p>
 WARNING	<p>This symbol indicates that a condition may result in harm, serious injury or death to you or other persons if this instruction is ignored.</p>
 CAUTION	<p>This symbol indicates that a condition may result in damage to your vehicle or its equipment if this instruction is ignored. Also this symbol alerts the operator's unstable operation.</p>
 IMPORTANT	<p>This symbol indicates emphasis on notable characteristics of working procedures, and information about technology for easier operation.</p>
NOTE	<p>This instruction is to give additional description to operator so that he/she can operate the machine more effectively.</p>

This manual includes “Very important safety tips for safe operation” as a chapter. Be sure to read this chapter before initial operation.

Designed for your world

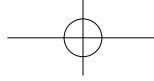

SYMBOL MARKS OF CONTROLLER

This manual includes symbol marks of the controller to simplify operations for maneuverability and maintenance. These meanings are as below, so carefully read it for a proper function.



PTO



Left side indicator



Right side indicator



Preheat



Engine oil pressure



Battery



Parking Brake



High beam



Low beam

Designed for your world

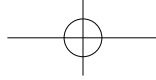

“USE AND DISPOSAL” POLICY CONCERNED WITH ENVIRONMENT PRESERVATION

We try our best to preserve the environment, and are always concerned about our environmental impact at each step of planning, development, production, distribution, use and disposal of products, and for our overall operations through an “environmentally friendly” management system. We comply with international environmental regulations, environmental regulations designated by country and local authorities and other requirements with which we are in agreement, and we work towards the prevention of environmental pollution and the conservation of resources. We provide environmental education and have an awareness campaign to raise environmental awareness among all our employees and members of the supporting companies.

We introduce the “Use and Disposal” policy concerned with environment preservation as follows.

1. Please read the operator’s manual though for global environment protection. Overload on the machine shortens the product life and increases the harmful exhaust gas which cause air pollution due to the incomplete combustion.
2. When replacing various fluids (for engine, transmission, hydraulics, etc.) by yourself, don’t dispose the used oil to anywhere not recommended. It can pollute the ground and water. Please contact your local dealer to dispose it legally.
3. Observe the operator’s manual and store or dispose the waste product properly. Rust, oil, etc leaked from waste product improperly stored can pollute the ground and water. Accordingly for a waste product disposal, contact the necessarily “approved waste collection and recycling facility” to discard the used materials legally.

Designed for your world

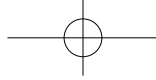

1. FOR SAFE OPERATION

SAFETY PRECAUTIONS..... 1-2

- BEFORE USING THE MACHINE1-2
- BEFORE WORKING1-11
- WHILE WORKING.....1-16
- AFTER USING THE MACHINE1-17
- PRECAUTION FOR PROLONGED STORAGE1-21
- OTHER.....1-23

DECAL MOUNTING LOCATION 1-34

- CAUTIONS FOR DECAL MAINTENANCE1-40

Designed for your world

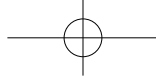

SAFETY PRECAUTIONS

If the instructions in this chapter are ignored, it may cause a machine failure, a fatal accident with injury or death.

For further detailed information, refer to each chapter.

NOTE

- Please understand that some of the figures or contents in this manual may not match with your own machine due to the product variation.
- This tractor is not designed for road driving. Please use a truck to move this machine on the public roads.

BEFORE USING THE MACHINE

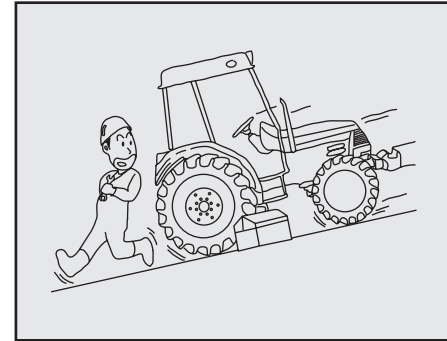
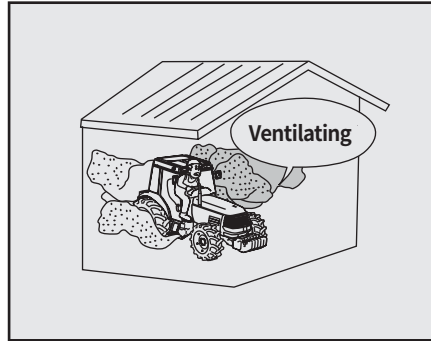

⚠ WARNING

Beware of exhaust gas;

- Running the engine, repairing (tightening) any painted part or grinding any painted area should be performed only in a well-ventilated area.

If this instruction is ignored, the exhaust gas or dust can cause intoxication and lead to fatal consequences.

⚠ WARNING

Wide and flat enough area;

- Inspect or repair the tractor on a wide and flat area.

If this instruction is ignored, an unexpected accident may occur, such as overturning of the tractor.

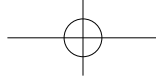

! WARNING

Clean and arranged place;

- Do not mess the place by dust, mud, oil, or parts

If this instruction is ignored, an unexpected accident may occur.

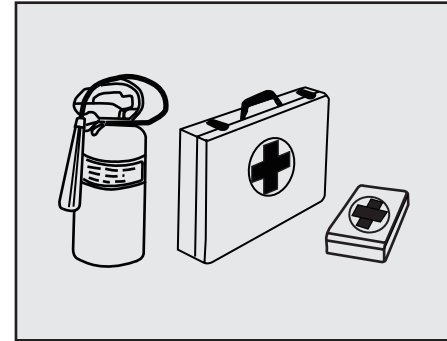
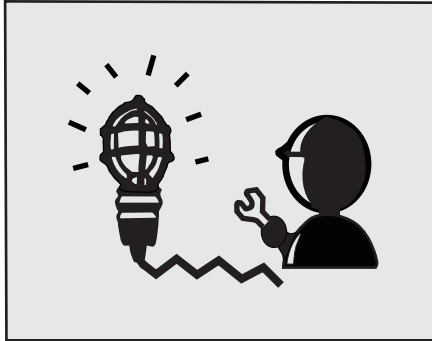

1

! WARNING

Carry out maintenance in a well-lit place;

- Make sure work area is properly lighted.
- Use safety work lights with protective covering when working inside or under the machine.

If this instruction is ignored, an unexpected accident may occur, possibly fire or explosion.

! WARNING

Prepare for emergencies;

- Keep a first aid kit and fire extinguisher handy at all times while operating machine.

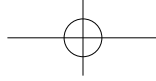

1-4 Designed for your world

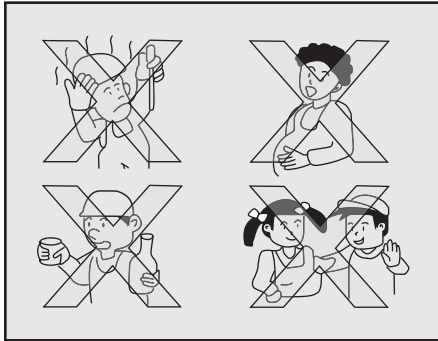

WARNING

Do not drive if you are;

- Unable to concentrate because of fatigue, under treatment of medicine.
- Under the influence of alcohol
- Pregnant
- Under the age of 18

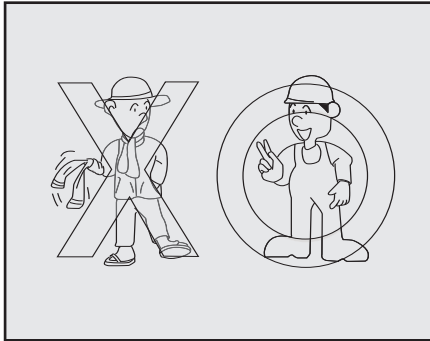

WARNING

Wear properly for the job;

- Hair band, loose clothing is not allowed. Wear tight clothes, work hat, and work shoes which have rough bottoms against slippery surface.

If this instruction is ignored, you will be exposed to a risk of being entangled, slipping, or falling.

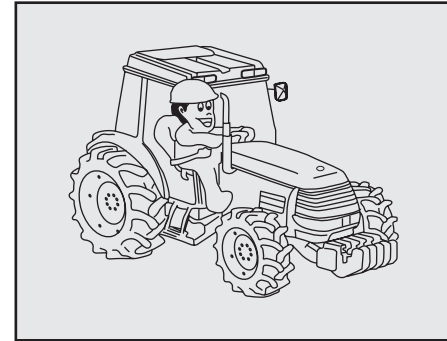

WARNING

Use only recommended implements;

- Be sure to use only implements which are recommended by manufacturer.

If this instruction is ignored, an unexpected accident may occur or tractor may not perform properly.

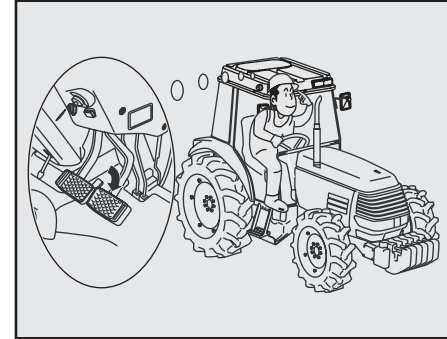
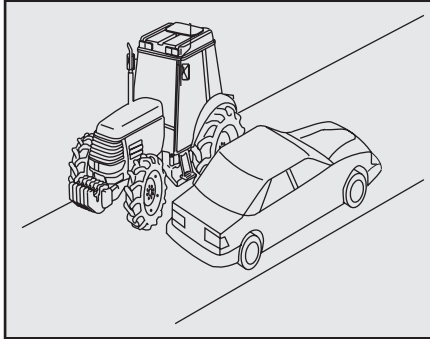
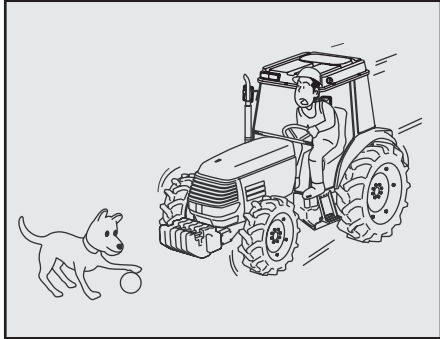

! WARNING

Start the machine slowly after reminding bystander;

- Start the engine after reminding bystanders of your intention. Do not start the machine abruptly.

If this instruction is ignored, unexpected accident or injury can happen.

! WARNING

Pay attention to the shoulder of the road;

- When moving along the unpaved road with ditches or slanted sides, pay attention to the shoulders.

If this instruction is ignored, there is a risk of falling over.

! WARNING

Interlock the brake pedals (left and right) when driving on a road;

- Make sure to interlock the brake pedals (left and right) when driving on a road

If this instruction is ignored, there is a risk of abrupt turning or overturning due to one-sided braking.



1-6 Designed for your world

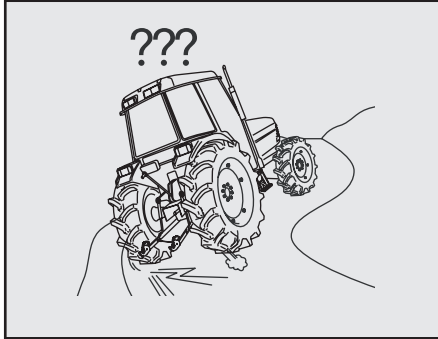

WARNING

Avoid rapid starting, braking, turning, and excessive speed;

- Start and stop the tractor slowly. Reduce engine speed when making a turn and driving on hilly or curved roads.

If this instruction is ignored, there is a risk of overturning or damage to the machine.

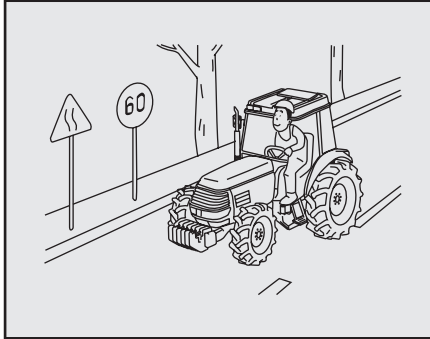

WARNING

Observe traffic regulations and drive safely;

- When driving on the road, observe the traffic regulations and wear a hard hat and seat belt.

If this instruction is ignored, there is a risk of accident or injury.

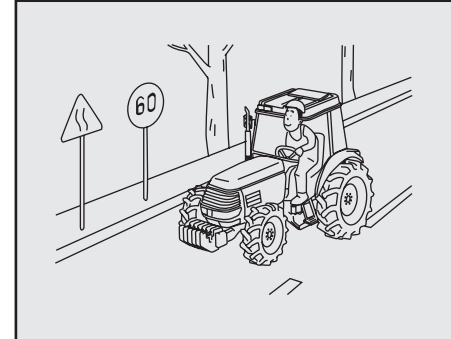

WARNING

Observe traffic regulations when driving on a road safely;

- If the machine is broke down and stopped on the road, move the machine to a safe place out of the road.

If this instruction is ignored, there is a risk of accident or injury.

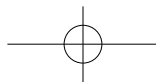

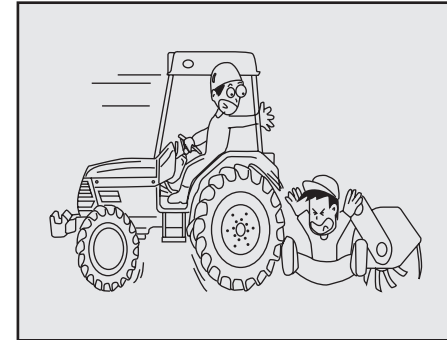
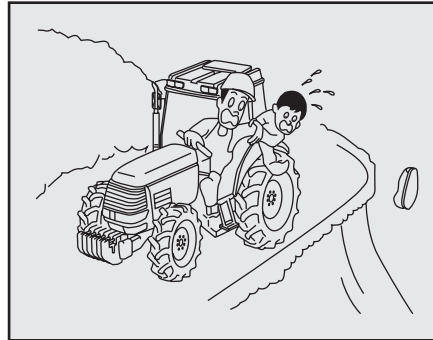
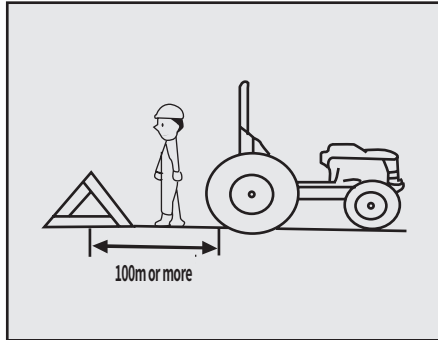
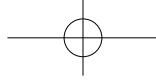

1

! WARNING

Put machine shut down sign if the machine is stopped on the road;

- If the tractor is stopped on the road due to the machine failure, put the machine shut down sign (Emergency triangle reflex reflector) at least 100~200 yards before failed machine in accordance with local traffic laws.

If this instruction is ignored, the machine can be hit by a car and cause a traffic accident with injury or death.

! WARNING

Only driver should be aboard the tractor while in operation;

- This tractor is designed to allow only one operator. The driver must not allow anyone else to get on the tractor.
- Especially never allow children on the machine while in use.

If this instruction is ignored, an unexpected accident may occur.

! WARNING

Do not allow anyone near while operating the tractor or implement;

- When engaging or disengaging the implement by moving the tractor, make sure that no one is around the tractor or between the implement and the tractor.

If this instruction is ignored, there is a risk of accident or injury.

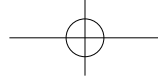

1-8 Designed for your world

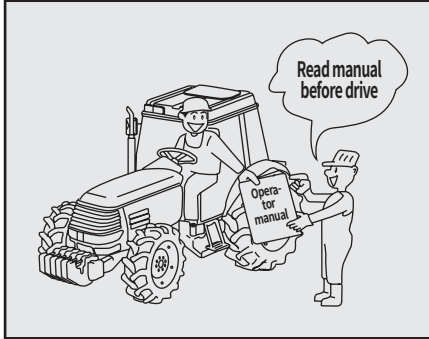
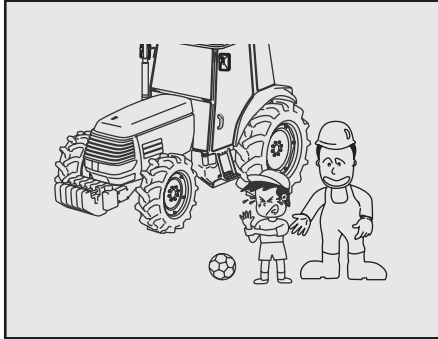

WARNING

Precautions for children;

- Fully warn the children and keep them away from the tractor at all times.

If this instruction is ignored, unexpected accident of injury can happen.

WARNING

Properly train anyone operating;

- Explain the handling tips in detail and make sure the driver reads the Manual before driving.

If this instruction is ignored, there is a risk of death, serious injury, or damage to tractor.

WARNING

Use Pesticides safely;

- Careless use of agricultural chemicals such as disinfectants, herbicide, pesticides, rat poison, and fertilizer can be harmful to environment and human body. Be sure to observe all relevant regulation and instructions to use the agricultural chemicals efficiently and safely. Then it may prevent injury or accident.

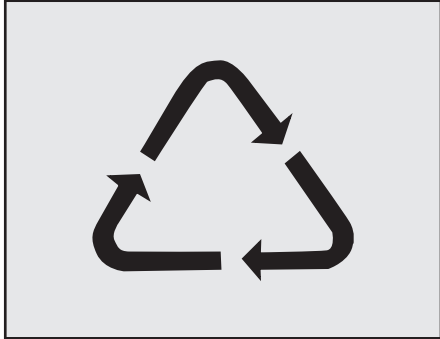
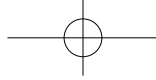

! WARNING

Observe all relevant regulations for disposal;

- Be sure to observe all relevant regulations when you dispose of the engine oil, transmission oil, fuel, coolant, filters and battery.
- Never dispose the used oil directly to the river or drainage, follow legal procedures.

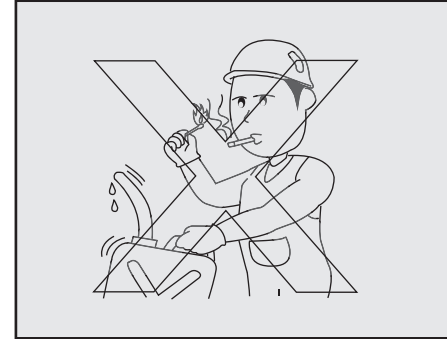

1

! WARNING

Observe all relevant regulations for disposal;

- Careless disposal of waste product can be harmful to environment and ecosystem.
- When draining the fuel and oil, use a proper container that is not leaking, not food or beverage containers to prevent from drinking. Do not bury the waste product in the ground or dispose to drainage.

! WARNING

No smoking or open flame when fueling;

- Do not smoke or use match or lighter while refueling.

If this instruction is ignored, fuel can catch fire and lead to explosion or fatal injury with burn.

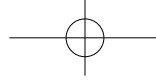

1-10 Designed for your world

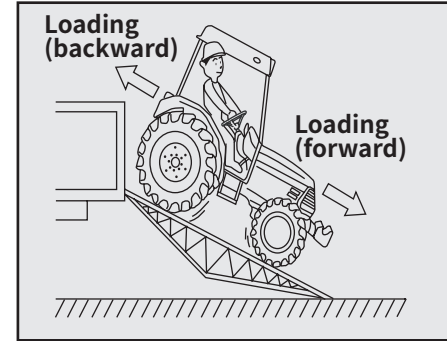
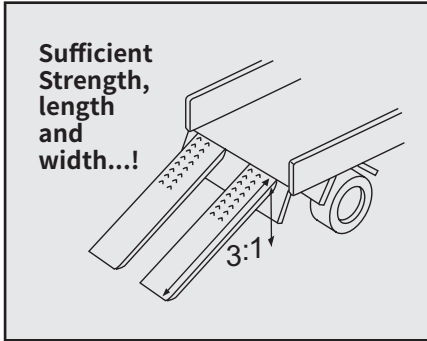
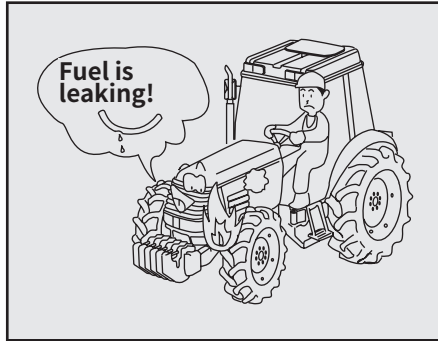

! WARNING

Inspect for fuel leaking;

- Check the fuel lines and hoses for damage or leakage

If this instruction is ignored, there is a risk of fire.

! WARNING

Consider the strength, length and width of loading ramps before using;

- Loading or unloading must be done on a flat and safe place, the tractor engine switched off, and the parking brake engaged. The loading ramps must be non-slip and have sufficient strength, length, and width for the tractor.

If this instruction is ignored, the tractor may roll backwards or fall off causing accident or injury.

! WARNING

Move the tractor backward when loading, and forward when unloading;

- Move the tractor backward when loading it on the truck, and forward when unloading from the truck.

If this instruction is ignored, the tractor may roll or fall off causing accident or injury.

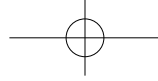

BEFORE WORKING

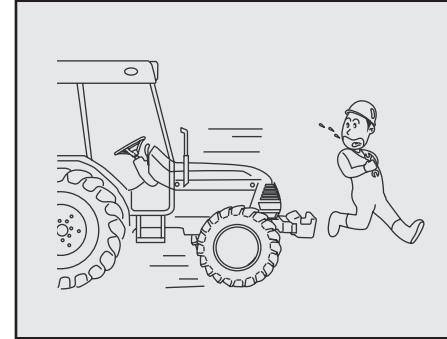
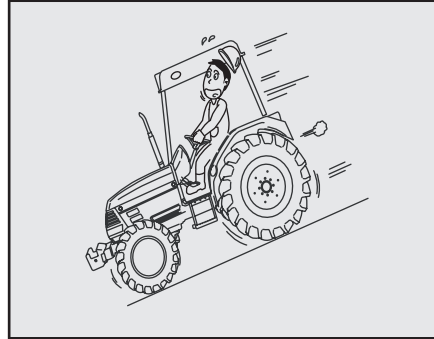
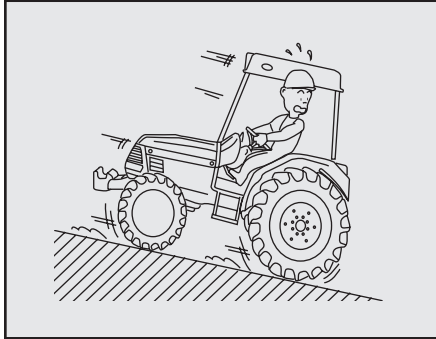

1

WARNING

Be careful when driving on the loading ramps;

- Be careful when driving on the loading ramps. Do not disengage the clutch, shift the main shift, range shift, or forward/reverse lever.

If this instruction is ignored, the tractor may roll backwards or fall causing accident or injury.

WARNING

Do not shift gears on slopes or on the loading ramps;

- When driving on slopes or on loading ramps, select the proper shift gear before approaching the loading ramps and then do not shift the gear on the loading ramps.

If this instruction is ignored, there is a risk of slipping, rolling, or overturning.

CAUTION

Stop the engine before maintenance;

- Stop the engine before maintenance when checking, repairing or cleaning the machine.

If this instruction is ignored, there is a risk of injury.



1-12 Designed for your world

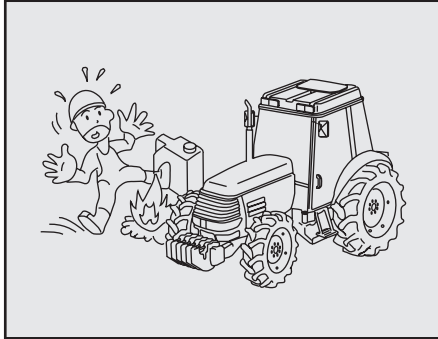

⚠ DANGER

Stop and cool down the engine before fueling or lubricating;

- Do not fill the fuel while the engine is running or machine is hot.

If this instruction is ignored, fuel can catch fire or lead to fatal injury with burn.



⚠ DANGER

No fire or spark near to the battery;

- No fire or spark near to the battery while checking and charging the battery.

If this instruction is ignored, the battery can cause a blaze or explosion and lead to a fatal injury or death.

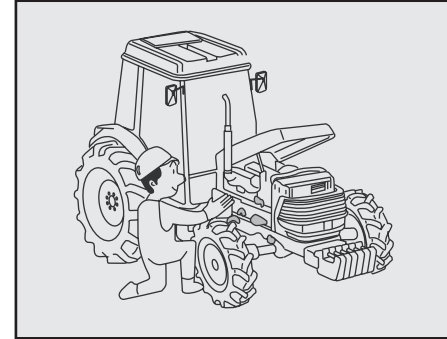

⚠ DANGER

Remove dirt and debris from muffler and engine before operating;

- Clean if there is dust, debris or fuel on the engine or muffler before operating the machine every day.

If this instruction is ignored, there is a risk of fire.

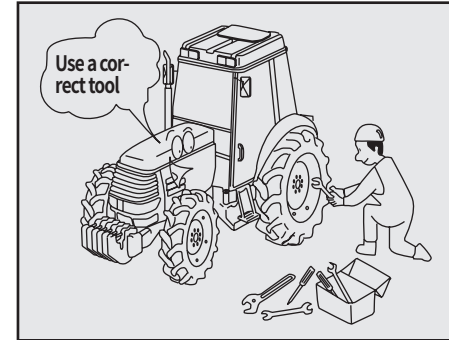
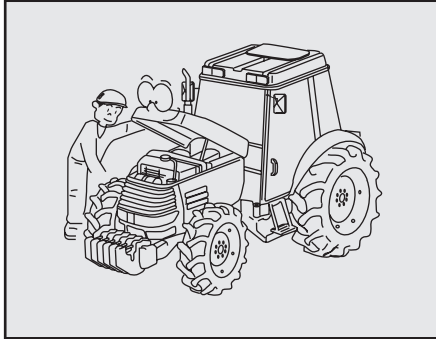

1

⚠ WARNING

Check electrical component and wire harness;

- Check before work if the wire harnesses are burned or stuck on any other component, if the cord cover is peeled off or if the wire connectors are loose.

If this instruction is ignored, the electrical short can cause fire and injury.

⚠ CAUTION

Do not over inflate tires;

- When filling tires with air, do not inflate it beyond the maximum pressure stated in this manual. (Refer to P5-22 of Proper inflation pressure)

If this instruction is ignored, the tire may blow out, causing an injury.

⚠ CAUTION

Use correct tools;

- Use proper tools to carry out all maintenance procedure. Also have available the required tools in the tractor at all times.

If this instruction is ignored, there is a risk of accident due to poor maintenance.



1-14 Designed for your world

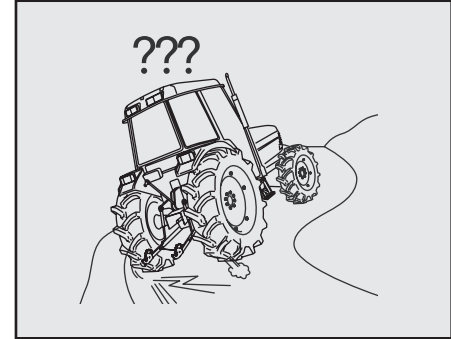
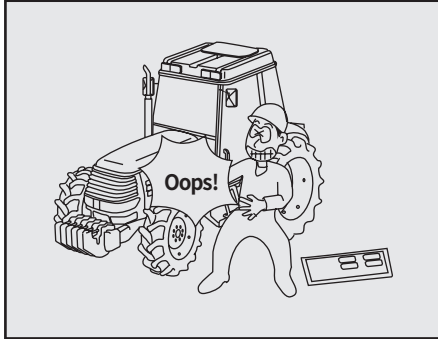

CAUTION

Secure hood and side covers before operating tractor;

- After detaching the covers for checking or maintenance, make sure to put them back in their place.

If this instruction is ignored, there is a risk that you may get entangled in the tractor or get injured.

CAUTION

Observe correct procedures when installing or removing the battery;

- Connect the (+) terminal first when installing the battery, and disconnect the (-) terminal first when removing it.

If this instruction is ignored, there is a risk of burn or fire due to short circuit.

WARNING

It is necessary to inspect the brake to and steering wheel;

- Check if the brakes work properly and evenly on both sides or if the steering wheel is loose.

If this instruction is ignored, there is a risk of accident.

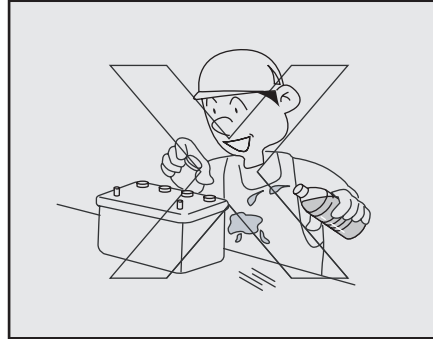
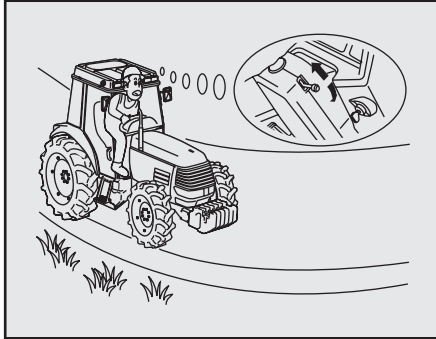
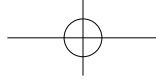

1

! WARNING

Lock tilt lever and telescopic knob when adjusting steering wheel;

- Except when you adjust the steering wheel, make sure that the tilt lever and telescopic knob are secured in the "No" and "Lock" positions.

If this instruction is ignored, the tractor may not turn properly, causing an accident.

! DANGER

Avoid contact with the battery solution;

- Be careful that your body or your clothes do not come in contact with the battery solution. If it contacts your skin, wash immediately with water.

If this instruction is ignored, it can burn your skin or clothes.

! WARNING

Be sure to check before and after using machine;

- Be sure to check the machine before and after using. Especially inspect and repair controls such as clutch, brake, lever, etc.

If this instruction is ignored, the machine can be broken or lead to an accident or injury.

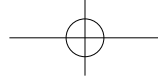

WHILE WORKING

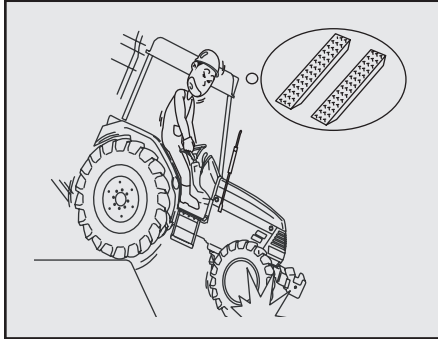

WARNING

Use the loading ramps when crossing a ditch or a dike;

- Be sure to use the loading ramps when crossing a ditch or dike, or when passing through soft land. The loading ramps must be suitable for the tractor in width, length and strength.

If this instruction is ignored, there is a risk of accident that the tractor may slip or turn over.

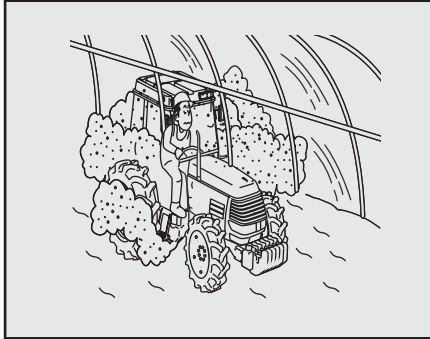

WARNING

Properly ventilate when working in a green house;

- Ventilate the green house to let out the exhaust gas.

If this instruction is ignored, the exhaust gas can cause intoxication and lead to fatal consequences.

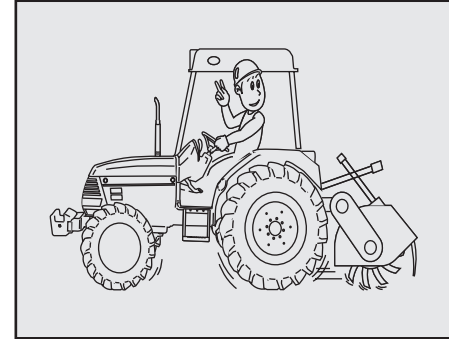

WARNING

Pay attention and keep hands on the steering wheel while driving;

If this instruction is ignored, there is a risk of accident or injury.

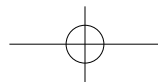

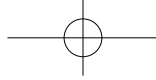

AFTER USING THE MACHINE

1

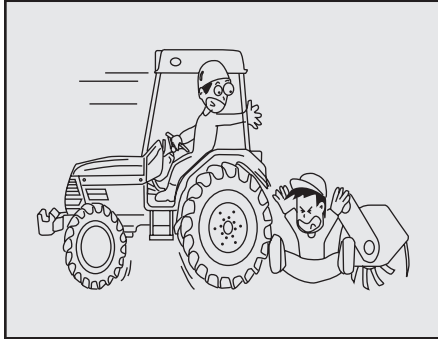

WARNING

Do not allow anyone near while operating the tractor or implement;

- When engaging or disengaging the implement by moving the tractor, make sure that no one is around the tractor or between the implement and the tractor.

If this instruction is ignored, there is a risk of accident or injury.

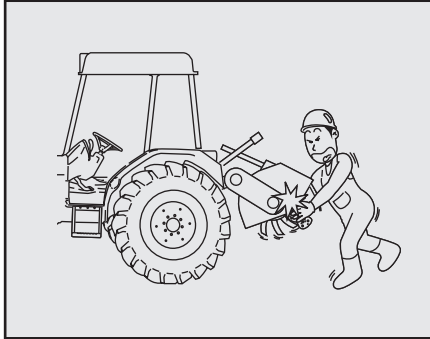

WARNING

Stop the engine when removing grass, etc. from blades of the cultivator;

- Stop the engine when removing grass, etc. from blades of the cultivator and lock the flow control valve not to lower the implement.

If this instruction is ignored, there is a risk that you will get entangled in the cultivator or sustain a serious injury due to lowering the implement.

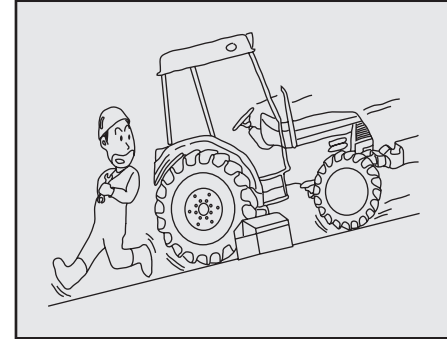

WARNING

Perform the maintenance on a level and safe location;

- Perform the maintenance on a level and safe location that will keep the tractor in place and will not cause a risk to people passing by. Before carrying out the maintenance, place blocks at the front and rear tires to prevent movement.

If this instruction is ignored, an unexpected accident may occur, such as overturning of the tractor.

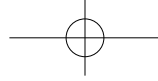

1-18 Designed for your world

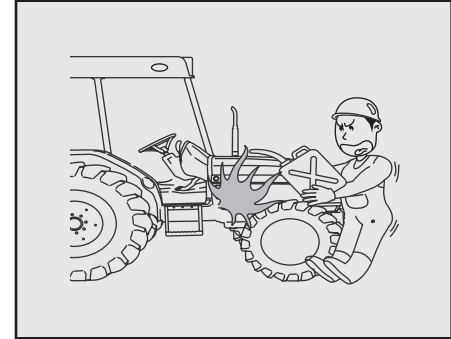
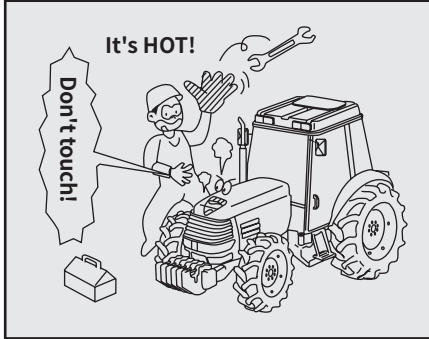
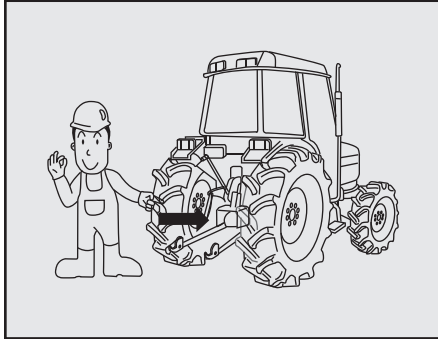

CAUTION

Cover the PTO shaft when not in use;

- When the PTO shaft is not in use, apply grease and keep it covered.

If this instruction is ignored, there is a risk that you may get entangled or get injured. Implement shaft installation on the PTO shaft will not be easy due to the rust on it.

CAUTION

Carry out maintenance after the parts have cooled down;

- Carry out the maintenance work after the heated area such as the muffler or the engine is fully cooled down.

If this instruction is ignored, there is a risk of getting burnt.

CAUTION

Stop and cool down the engine before fueling or lubricating;

- Do not fill the fuel while the engine is running or machine is hot.

If this instruction is ignored, fuel can catch fire or lead to fatal injury with severe burns.

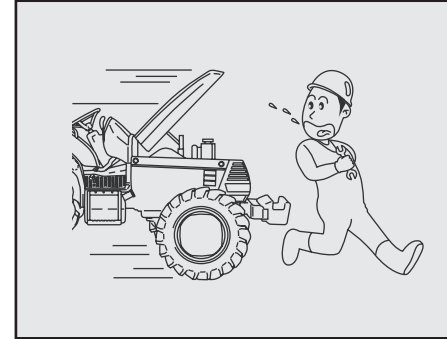
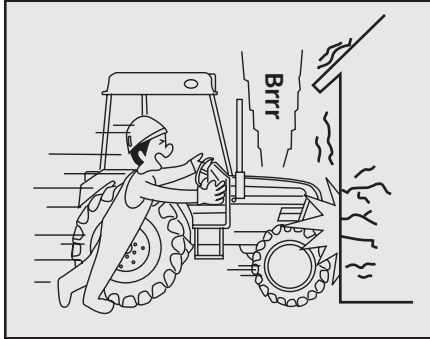
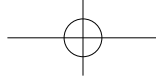

1

⚠ CAUTION

Be careful of high oil pressure;

- Make sure that the hydraulic coupling or the hose is not loose or damaged. Before separating the hydraulic coupling or the hose, eliminate the high pressure inside the hydraulic system by moving the control lever while engine is stopped.

If this instruction is ignored, the oil under high pressure may cause skin injury.

⚠ WARNING

Make sure that you are seated in the driver's seat with your seat belt fastened before starting engine;

- When starting the engine, make sure that you are seated in the driver's seat with your seat belt fastened and check the seat position and the safety of the tractor.

If this instruction is ignored, an unexpected accident may occur.

⚠ CAUTION

Stop the engine before maintenance;

- Stop the engine before maintenance such as checking, repairing or cleaning the machine.

If this instruction is ignored, there is a risk of injury.

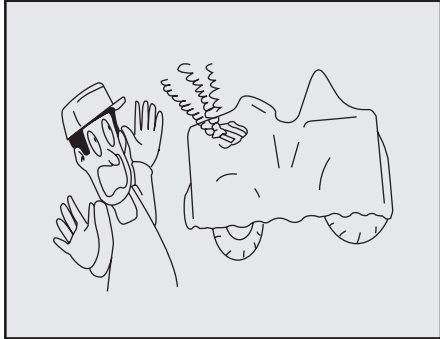
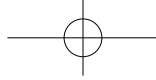

! WARNING

Put tractor rain cover on only after tractor has cooled down;

- Put tractor rain cover on only after parts such as the engine and muffler have cooled down.

If this instruction is ignored, there is a risk of fire.



! WARNING

Do not open the radiator cap when the radiator is hot;

- Never open the radiator cap when the radiator is heated.

If this instruction is ignored, hot water may spurt, causing burns or damage.

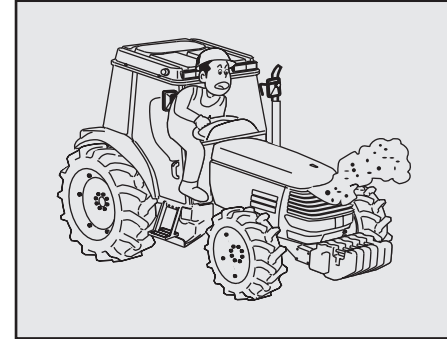

! WARNING

Remove dirt and debris from muffler and engine before operating;

- Clean if there is dust, debris or fuel on the engine or muffler before operating the machine every day.

If this instruction is ignored, there is a risk of fire.

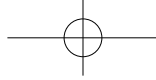

PRECAUTION FOR PROLONGED STORAGE

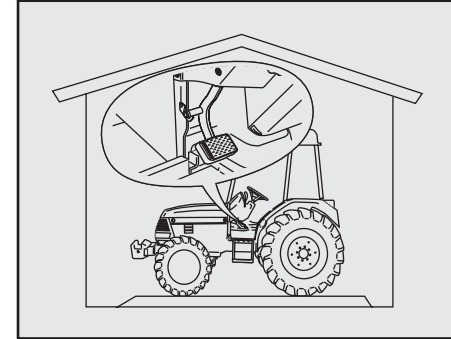
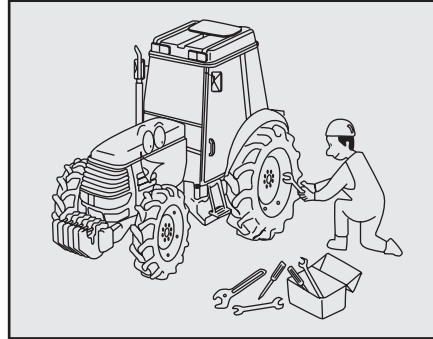
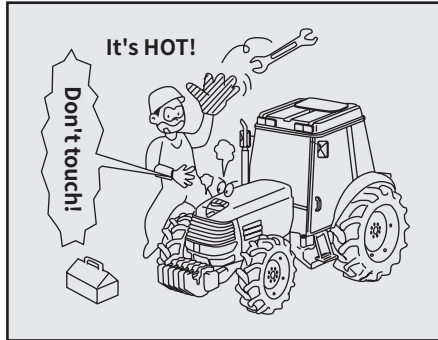

1

 **CAUTION**

Be careful of hot muffler;

- During operation and right after the engine is turned off, the muffler is very hot. Avoid touching it.

If this instruction is ignored, you may get burnt.

 **CAUTION**

After working, immediately repair if necessary;

- Immediately repair or replace the faulty parts.
 - Tighten the loose bolt and nut right away.

If this instruction is ignored, an unexpected accident may occur due to poor maintenance.

 **CAUTION**

Disengage the clutch when storing the tractor for a long time;

- When storing the tractor for a long period of time, make sure to put the clutch pedal in the disengaging position.

If this instruction is ignored, the clutch disc can be stuck to the fly wheel after long period time.

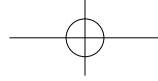

1-22 Designed for your world

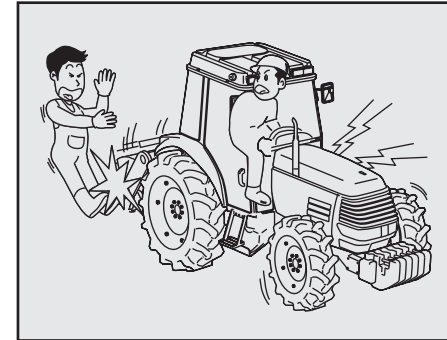
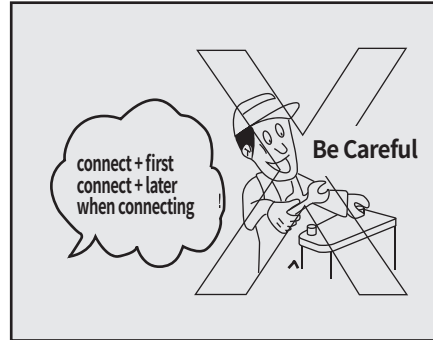
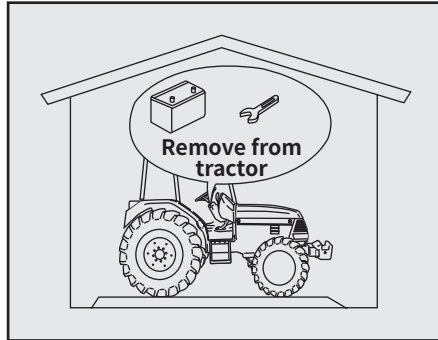

WARNING

Disconnect the Battery and the key when storing the tractor for a long period of time;

- When storing the tractor without use for a long period of time, park the machine on the leveled ground and clean each component, remove the battery and keep the key in a safe place.

If this instruction is ignored, battery power may be weakened and starting will be failed.

CAUTION

Observe correct procedures when installing or removing the battery;

- Connect the (+) terminal first when installing the battery, and disconnect the (-) terminal first when removing it.

If this instruction is ignored, there is a risk of burn or fire due to short circuit.

WARNING

Confirm that the implement is down on the ground when starting the engine;

- When starting the engine, confirm that the control lever is on "Lowest" position.

If this instruction is ignored, implement may come down suddenly and cause an injury.

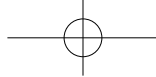

OTHER

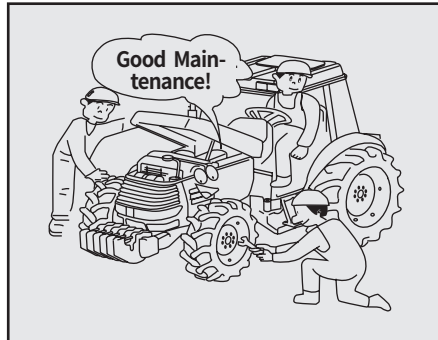

! WARNING

Maintenance periodically;

- After using tractor, visit your local dealer for maintenance, such as oil change and filters.
- Contact the local dealer to discard the parts (battery, etc.) or waste materials.

If this instruction is ignored, there is a risk of accident due to poor maintenance.

! WARNING

Do not adjust or repair following components. Consult your local TYM dealer for these repair;

- Injection capacity and timing of the engine fuel injection pump.
- Correction and repair of hydraulic system (safety valve, hydraulic pump, brake valve, PST cylinder, SCV valve).

There is a risk of accident or injury or machinery breakdown. Remember it may cause the warranty cancellation.

If this instruction is ignored, consult your local TYM dealer for those repair and adjustment.

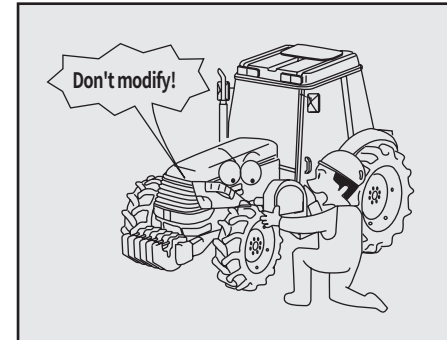

1

! CAUTION

Do not modify the tractor;

- Use only the genuine parts or other approved parts. Do not modify the tractor.

If this instruction is ignored, there is a risk of accident or injury or machinery breakdown. Remember it may cause the warranty cancellation.

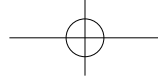

1-24 Designed for your world



WARNING

Pay attention when turning with implement;

- Depending on implements, the overall length may become very long. Pay particular attention to people or objects nearby when making a turn.

If this instruction is ignored, there is a risk of person injury or a collision of the implement.

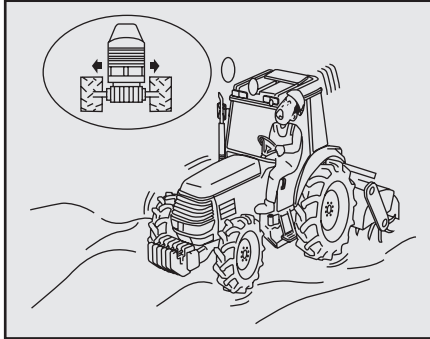

WARNING

Move wheels to widest setting (width between left and right tires) when working slope or when towing;

If this instruction is ignored, there is a risk of turning over.

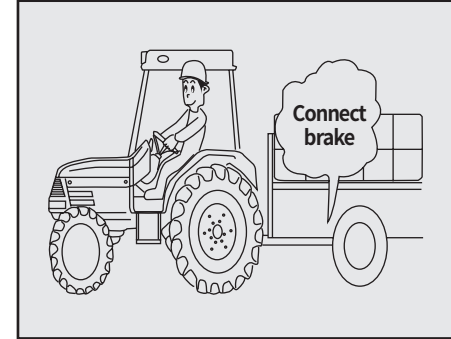

WARNING

Use caution sign when towing a trailer;

- Link the brake of the trailer with the brake of the tractor. Do not shift gears when driving on a hill.

If this instruction is ignored, there is a risk of accident or injury.

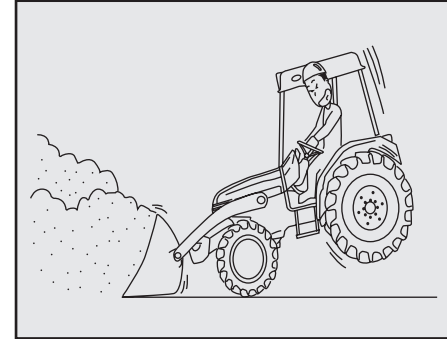
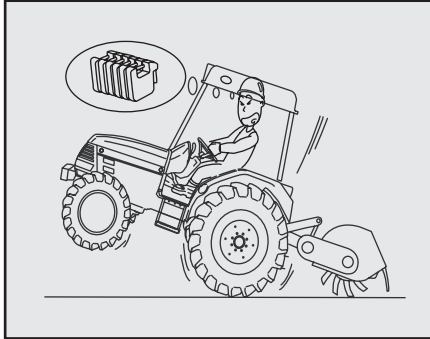
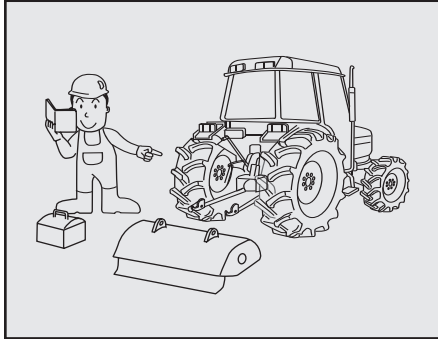

1

! WARNING

Follow the instruction manual when engaging an implement;

- When engaging an implement to the tractor, follow the instruction manual for the implement.

If this instruction is ignored, there is a risk of personal injury or damage to the tractor.

! WARNING

Balance a heavy implement with weights;

- When engaging a heavy implement, load the weights on the front of tractor to keep the balance of the tractor.

If this instruction is ignored, there is a risk of accident or injury due to loss of balance.

! WARNING

Pay attention to the balance between the front and rear side during the front-end-loader operation;

- During the front-end-loader operation, apply weights or implement to avoid losing balance between the front and the rear side of tractor.

If this instruction is ignored, there is a risk of overturning accident due to loss of balance.

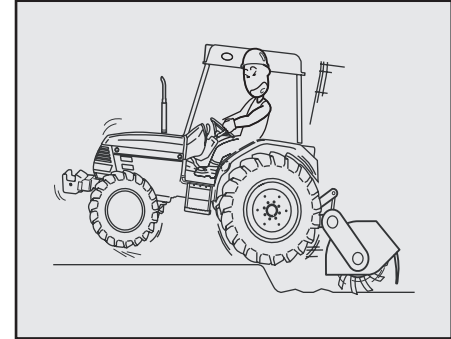
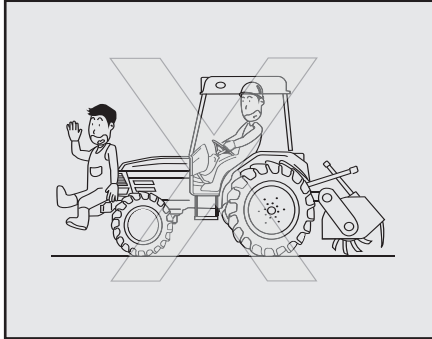
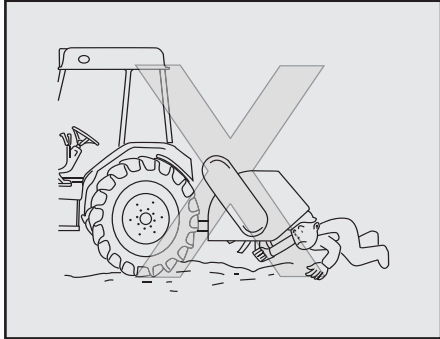
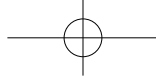

! WARNING

Do not get under or put your feet under the implement;

- Do not get under or put your feet under the implement.

If this instruction is ignored, the implement unit may fall down and there is a risk of injury.

! WARNING

Do not substitute balance weights with a person or anything else;

- Do not use a person or anything else in place of the balance weight. Use only genuine balance weight.

If this instruction is ignored, there is a risk of accident or injury.

! WARNING

Be careful of unexpected movement when using the rotary tiller;

- When working with the rotary tiller, put the tiller slowly on soft or rocky ground. The tractor may be pushed in an unexpected direction by the rotating force of the tiller.

If this instruction is ignored, there is a risk of accident or injury.

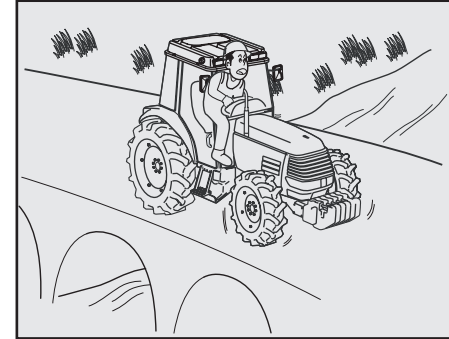
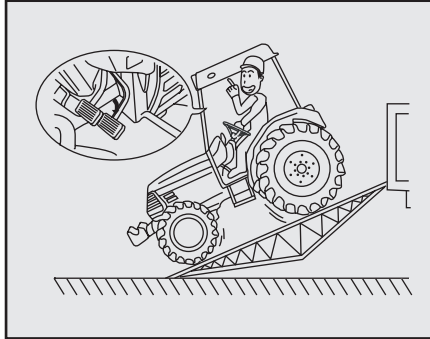
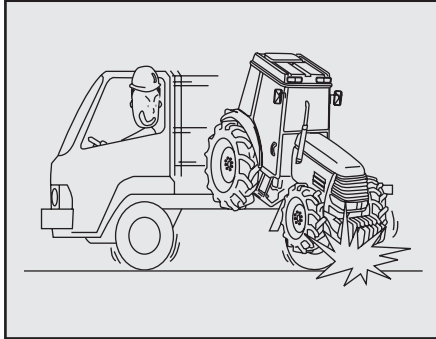
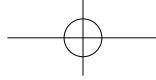
**! WARNING**

Properly secure tractor during transport;

- When transporting the tractor, apply the parking brake with gear engaged and fasten the tractor to the truck securely using ropes or belts with sufficient strength.

If this instruction is ignored, There is a risk of accident that the tractor may fall off the truck.

! DANGER

Interlock the brake pedals for both sides when loading or unloading the tractor;

- It is necessary to interlock the brake pedals for both sides when loading or unloading the tractor.

If this instruction is ignored, the tractor may overturn due to one-sided braking when the brake pedal is depressed in an emergency.

! WARNING

Release the differential gear lock when making a turn;

- Make sure to release the differential gear lock when making a turn.

If this instruction is ignored, the tractor may not turn to the intended direction and cause an accident.



1-28 Designed for your world

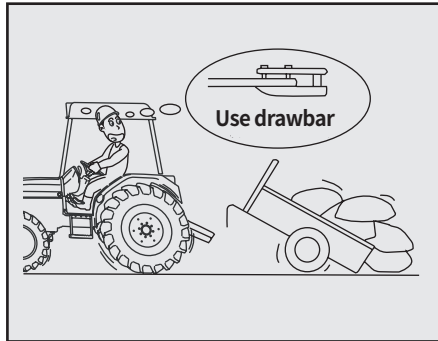

WARNING

Use the drawbar when towing;

- Make sure to use the drawbar when towing. Never tow anything with the top link or the lower links.

If this instruction is ignored, the tractor may turn over.

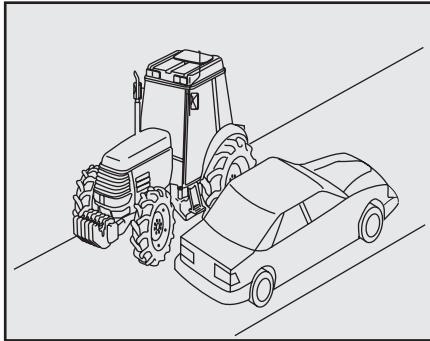

WARNING

Pay attention to the shoulder of the road;

- When moving along the unpaved road with ditches or slanted sides, pay attention to the road shoulder.

If this instruction is ignored, there is a risk of falling over.

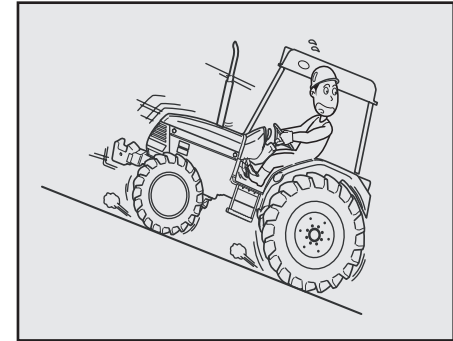

WARNING

Be careful when driving on a hill;

- Be careful when driving on a hill. Do not disengage the clutch on the hill. Do not shift the main shift lever, range shift lever, or shuttle lever in [neutral] on the hill.

If this instruction is ignored, the tractor may roll backwards or fall causing accident or injury.

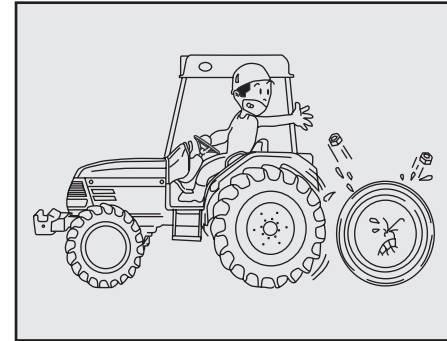
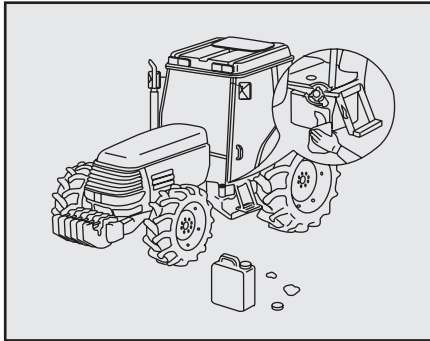
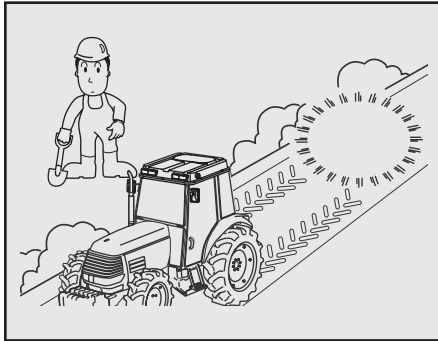
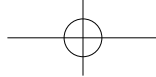

1

! WARNING

Turn off engine in a level area when leaving the tractor;

- When leaving the tractor, park the tractor on a level and safe area, turn off the engine, and apply the parking brake. Also, lower the implement on the ground.

If this instruction is ignored, the tractor may move and cause an accident.

! WARNING

Remove spilled excess fuel after closing the fuel cap;

- After filling the fuel tank, close the fuel filler cap completely and wipe off the excess fuel thoroughly.

If this instruction is ignored, there is a risk of fire.

! WARNING

Be aware of the PTO RPM requirements for the implements;

If this instruction is ignored, there is a risk of accident or injury.

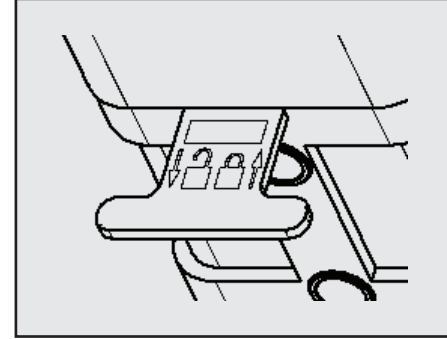
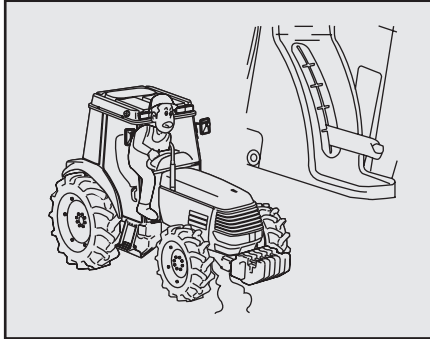
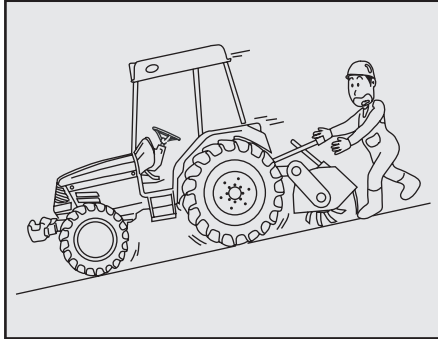

! WARNING

Only engage or disengage implements on flat, level area:

- Engage or disengage the implement on a flat and safe place. Supply proper lighting at all times and especially night.

[Otherwise]

There is a danger of accident.

! CAUTION

Engage the parking brake during warming up the engine;
If this instruction is ignored, the tractor may move and cause an accident or injury.

! WARNING

- Check and perform maintenance to loader after lifting it. And fix the joystick safety lever when dismantling.

[Otherwise]

There is a danger of an unexpected death accident.

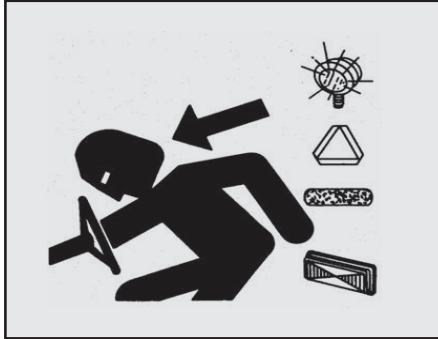
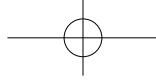

1. When the tractor has an implement attached or is moving slowly, you must often watch the rear side traffic status to avoid a collision accident when travelling on the road. In particular, be careful when you change directions. If necessary, the signal must be given by hand or direction indication lamp must be used.
2. Always turn on the head light, and/or emergency lamp at night and day as requested by the local traffic regulation.

3. Maintain the light and indication plate so it can be visible always. Immediately repair or attach the broken or missed light and indicating plates.



1

1. Entanglement in rotating drive-line can cause serious injury or death.
2. Keep tractor master shield and drive-line shields in place at all times. Make sure rotating shields turn freely.
3. Understand service procedure before doing work. Keep area clean and dry.



1-32 Designed for your world



4. Never lubricate, service, or adjust machine while it is moving. Keep hands, feet, and clothing from power-driven parts. Disengage all power and operate controls to relieve pressure. Lower equipment to the ground. Stop the engine. Remove the key. Allow machine to be cooled.
5. Securely support any machine elements that must be raised for service work.

6. Keep all parts in good condition and properly installed. Fix damage immediately. Replace worn or broken parts. Remove any buildup of grease, oil, or debris.
7. On self-propelled equipment, disconnect battery ground cable (-) before making adjustments on electrical systems or welding on machine.
8. On towed implements, disconnect wiring harnesses from tractor before servicing electrical system components or welding on machine.

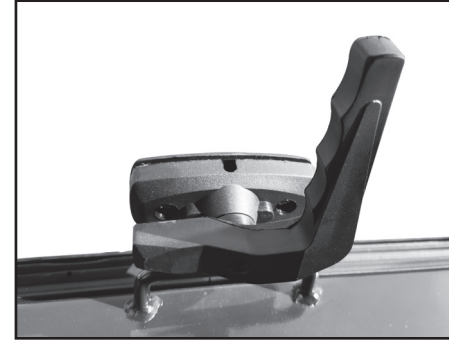

► LOCATION AND METHOD OF OPENING OF EMERGENCY EXITS

Removable rear cab window provides a large exit path if the cab door is blocked in an emergency situation.

The following items, maintenance and adjustment should not be attempted, but contact the nearest authorized dealer, if necessary.

1. Adjustment of injection pump without pre-approval may cause to deteriorate the durability and performance of the engine and may cause a fatal malfunction.
2. Adjustment of hydraulic pressure set at shipment may cause a fatal failure of related components and a subsequent accident.
3. If you intend to adjust the components that may deteriorate durability and performance, always contact your nearest authorized dealer or service department of the head office.

[Otherwise]

Be careful it may cause a fatal error or may not be covered by the warranty.

Use agricultural chemicals in a safe manner.

1. Agricultural chemicals must be sprayed properly.
2. Spraying of agricultural chemicals must be noticed in advanced and damage to the surroundings.
3. Do wear the protective clothing (mask, glove) for agricultural chemicals before spray work.
4. Clean the equipment and tractor just after spraying work.

[Otherwise]

You may be exposed to agricultural chemicals by wind.

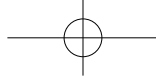

1-34 Designed for your world

DECAL MOUNTING LOCATION



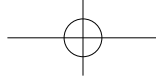

FOR SAFE OPERATION 1-35

1

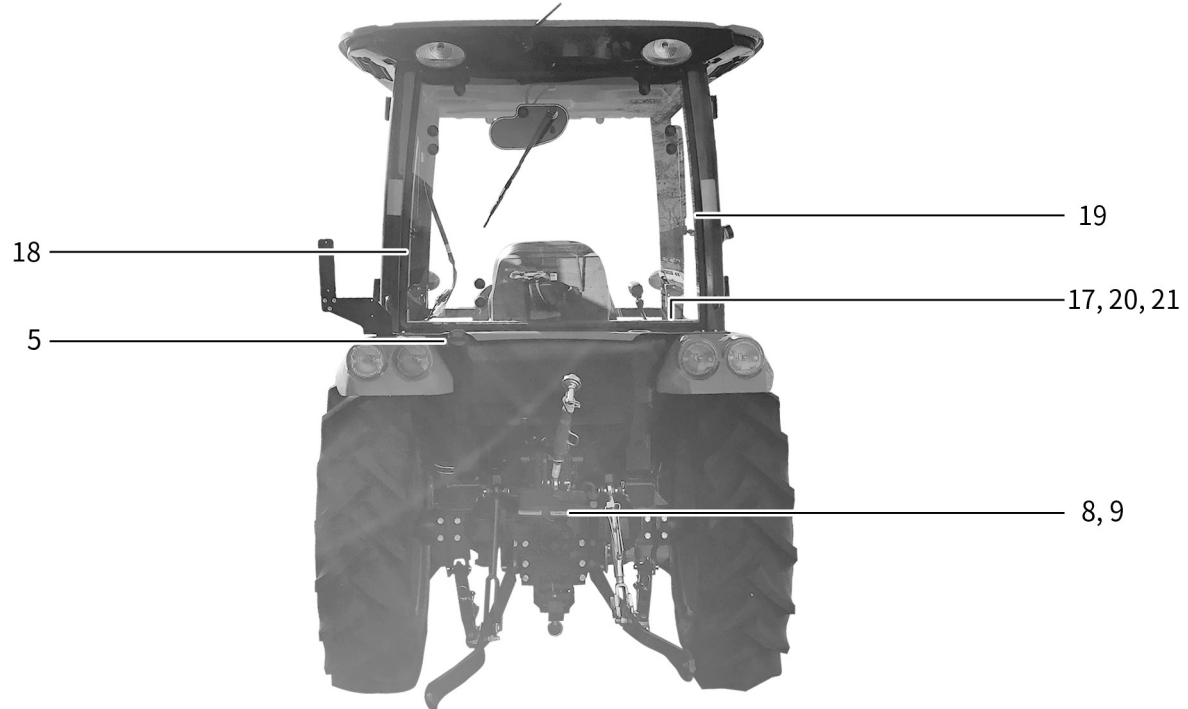

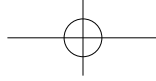

DECAL

(1) No.: TA00036924B



(2) No.: TZE5130000D4



(3) No.: TZE5180000C4



(5) No.: TZE4190000E4

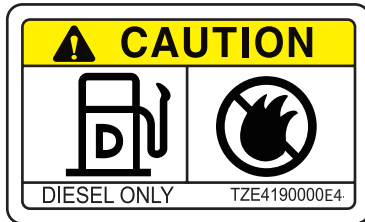

(6) No.: TZE5110000D4

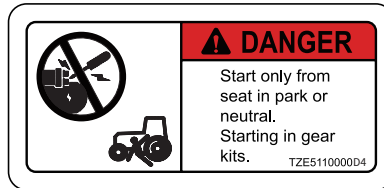

(7) No.: TZE5160000B3

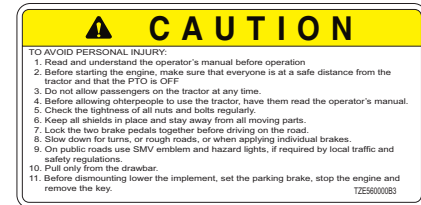

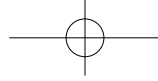

(9) No.: TZE5140000C3

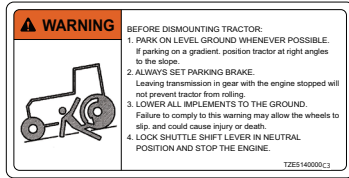

(10) No.: TZE5120000B4



(11) No.: TA00015596B

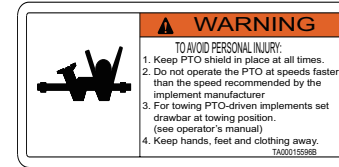

1

(12) No.: TZE4100000B4

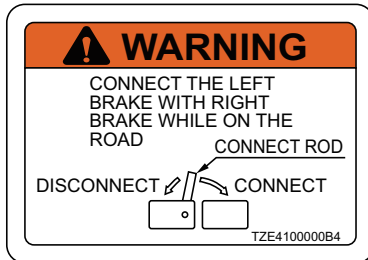

(13) No.: TZE5770000B3

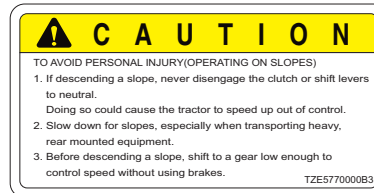

(14) No.: NTE5150000D4

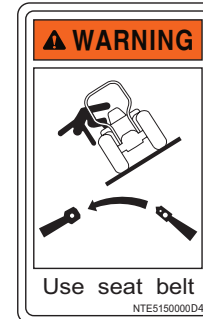

1-38 Designed for your world

(16) No.: NTE522000C4

WARNING

This structure's protective capability may be impaired by structural damage, overturn, or alteration. If any of these conditions occur, the structure must be replaced.

NTE522000C4

(17) No.: TA00059067A

WARNING

Breathing diesel engine exhaust exposes you to chemicals known to the state of California to cause cancer and birth defects or other reproductive harm

- Always start and operate the engine in a well-ventilated area.
- If in an enclosed area, vent the exhaust to the outside.
- Do not modify or tamper with the exhaust system.
- Do not idle the engine except as necessary.

For more information go to www.P65Warnings.ca.gov/diesel.

TA00059067A

WARNING Cancer and Reproductive Harm - www.P65Warnings.ca.gov.

(18) No.: TA00028504A

Caution

Engine Oil
Before using the machine please check the engine oil level. If low please add oil before operating the unit. Do not mix oil. Only use oil from one manufacturer as a first.

Coolant
Before using the machine please check the coolant level in the coolant tank below the bottom line, please add if below coolant level. Do not pour your sweat into the radiator. During the winter time always use anti-freeze coolant.

Fuel Filter
If water is present in the fuel bowl, drain the water immediately. Clean filter element every one hundred hours. In any event or damage to element, please replace the filter.

Air Cleaner
Before using the machine please check the air filter and clean or replace. Replace air filter every one hundred hours.

Air Breather
Follow instructions listed in the operator manual.

Using the Parking Brake

- When engaging or disengaging the parking brake, please press the brake pedal fully before moving the parking brake lever.

Caution

- Suddenly engaging or disengaging the shifting levers could cause severe damage to this unit and or harm to the operator.

Caution when starting on a slope

- When starting on a slope please ensure that both brake pedals are fully engaged. Once you have shifted the unit to gear, slowly release the brakes as the tractor begins to move in the forward position.

TA00028504A

(19) No.: TA00028501A

Warning

- Work in ventilated area.
- Do not work long hours air conditioner, because it make exhaust air. If you don't have an air cleaner, open the door and outside air into the area.

Caution

Always ensure the tires are inflated to the correct level as per the air fill instructions on the tire. Always check the tire pressure before the operator starts work.

Starting

1. Do not use a screwdriver or any other tool to start the motor as a means of cranking the unit.
2. The operator should only start the unit from the operator's platform can cause serious injury.
3. When starting the unit it is critical to ensure the engine will start. If the engine does not start, the operator should stop the engine and check the fuel system.
4. When starting the unit, please ensure that safety devices are fully engaged. For example always wear your seat belt and ensure the safety harness is fastened.
5. Make sure the air filter is clean and the air filter element and pleats are all clean. Check the air filter element. This includes emptying, cleaning, replacing, opening a window, or using a fan.
6. After starting the unit, please ensure that the engine is running and the unit is in the correct position.
7. If the engine does not start, please check the fuel system, the air filter, and the battery.
8. If the engine does not start, please check the battery, the fuel system, the air filter, and the battery.
9. If the engine does not start, please check the battery, the fuel system, the air filter, and the battery.
10. If the engine does not start, please check the battery, the fuel system, the air filter, and the battery.

Driving

1. When starting on a slope or uneven surface please reduce your speed.
2. When backing down hill please shift into low range before you begin working.
3. Do not operate this unit in reverse or create obstacles the operator is not used to work in these conditions.
4. When driving on a slope, please ensure that the unit is in the correct position.
5. When driving the tractor make sure that the two brake pedals are locked together, and do not engage differential lock while moving.
6. The operator should be the only person on the tractor.
7. Do not work on the tractor or implement connections without being fully secured to the tractor. Do not work on the tractor or implement connections without being fully secured to the tractor.
8. Do not work on the tractor or implement connections without being fully secured to the tractor.
9. Do not work on the tractor or implement connections without being fully secured to the tractor.
10. Do not work on the tractor or implement connections without being fully secured to the tractor.

Operating

1. Use caution in wet conditions, falling suddenly can cause the tractor to become stuck.
2. When operating the unit, always maintain a safe working speed.
3. When operating the unit, always maintain a safe working speed.

Parking

- When using the tractor make sure all implements or attachments are on the ground before turning off the engine. The tractor should not exit the field.
- When parking on a slope always apply the parking brake and chock the tire.

Service

- Before working on the machine always turn the engine off.
- Before working on the machine always disconnect the negative terminal of the battery.
- Do not touch the battery terminals or any other electrical components unless you are qualified to do so.
- Always wear eye protection when working on the battery.
- Always wear eye protection when working on the battery.
- Always wear eye protection when working on the battery.

Caution

- When the joystick is not being used, always put it in the locked position.

TA00028501A

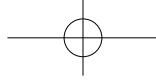

(20) No.: TA00037417A

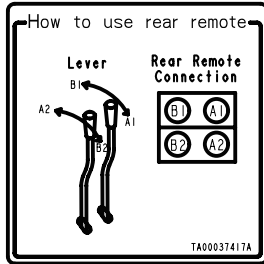

(21) No.: TA00072178B

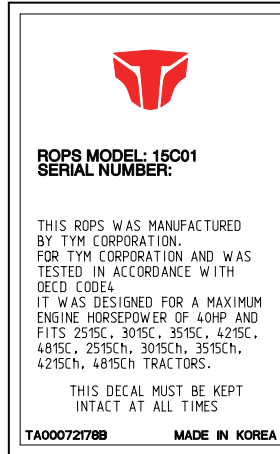

1

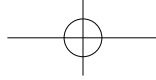

CAUTIONS FOR DECAL MAINTENANCE

Safety decals are attached to the tractor for safe operation. Make sure to follow the instruction on the decals as well as the following instruction:

CAUTION

- Keep the decals clean and intact. If any decal is dirty, wash it with soap and dry with a soft cloth.
- Never use a solvent such a thinner or acetone, since it can ruin the decals.
- Do not spray high-pressure water directly onto the decal. The decal may fall off the tractor.

IMPORTANT

- If a decal is damaged or lost, contact your local TYM dealer immediately to install a new decal.
- Make sure to attach the decal in the correct position cleanly without bubbles after cleaning its mounting surface.
- If a decal is attached to a component to be replaced, replace the decal as well.

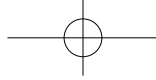

2. REGARDING WARRANTY SUPPORT

REGARDING WARRANTY CERTIFICATE2-2

REGARDING AFTER-SALES SERVICE2-2

 VEHICLE IDENTIFICATION NUMBER (VIN)2-2

REGARDING SUPPLYING SERVICE PARTS2-3

REGARDING GENUINE PARTS AND FLUID 2-3

Designed for your world

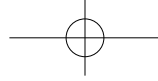

REGARDING WARRANTY CERTIFICATE

WARNING

- Do not modify the machine. If it is damaged by unapproved modification and misuse against description of manual, it will not be covered under warranty.

REGARDING AFTER-SALES SERVICE VEHICLE IDENTIFICATION NUMBER (VIN) PRODUCTION SERIAL NUMBER

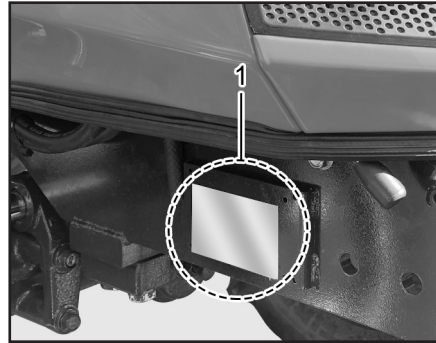

(1) Model And Production Serial Number

The manufacturer's serial number is marked on the serial number decal which is attached to the front right side of the front axle bracket.

ENGINE SERIAL NUMBER

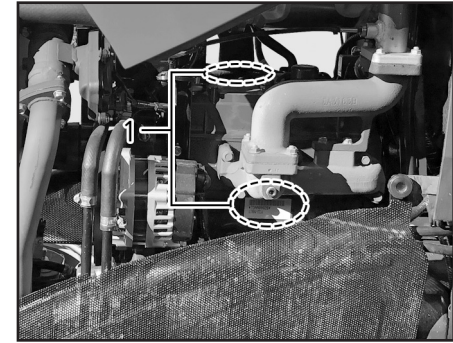

(1) Engine Serial Number

The engine number is stamped on the cylinder block and is specified on the decal which is attached to the cylinder block on the left side of the engine. Also, the decal indicating the engine model and standards is attached on the top of the engine cylinder head cover.



REGARDING SUPPLYING SERVICE PARTS

▶ REGARDING AFTER-SALES SERVICE

If you have a problem on your machine, refer to “Troubleshooting” of chapter 7 to check by yourself. Or contact immediately to authorized **TYM** dealer nearby.

▶ BE PREPARE FOR THE FOLLOWING QUESTION BEFORE CALLING

- Model and product serial number
- In case of engine failure, engine serial number
- Working conditions (What kind of job and how fast)
- Run hour of machine
- Describe the problem in detail as possible

We supply the service parts in accordance with the separated quality assurance regulation.

Consult your local dealer for availability and pricing.

REGARDING GENUINE PARTS AND FLUID



The **TYM** genuine parts and fluid are passed severe durability and performance test. Please use **TYM** genuine parts for your safety.

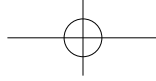

MEMO

A large, empty rectangular area with rounded corners, defined by a thin gray border, intended for writing a memo.

Designed for your world



3. SPECIFICATIONS

MAJOR SPECIFICATIONS 3-2

DRIVING SPEED 3-5

Designed for your world

MAJOR SPECIFICATIONS

Items		T3025 (CH)	
Engine	Model Name	T1700N6 IDI	
	Aspiration	Natural	
	Emissions Standards	Tier 4	
	Gross Power	hp(kW)	24.0 (18.0)
	PTO hp	hp(kW)	18.3 (13.4)
	No. of Cylinders		3
	Displacement	cu.in(cc)	104.5 (1,714)
	Rated Revolution	RPM	2,100
	Max Torque	lb-ft(Nm)	68.6 (93.0)
	Fuel Tank Capacity	gal(ℓ)	7.1 (27.0)
	Fuel Consumption	gal/hr(ℓ/hr)	1.69(6.4)
	Air Cleaner		Dry Element
	Alternator	12V	70A

※Dimensions and weights are based on 7-16 / 11.2-24.

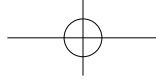

Items		T3025 (CH)
Drivetrain	Transmission	Hydrostatic
	Forward/Reverse Method	HST
	4 Wheel Drive	2WD/4WD
	No. of Traveling Speeds	3 range
	Forward Traveling Speed mph(km/h)	14.60 (23.5)
	Reverse Traveling Speed mph(km/h)	14.60 (23.5)
	Clutch	No
	Brake	Wet, Multi-disc
	Differential Lock	STD
	Creeper	No
	Cruise Control	Standard
Hydraulics	Power Steering	Hydrostatic Power Steering
	Total Hydraulic Flow (POWER STEERING+Implement) gpm/ lpm	11.3 (4+7.3) @ Rated RPM / 42.8 (15+27.8) @ Rated RPM
	Lift Control Type	Position
	Joystick Valve	STD
	Rear Remote(Port)	Optional (Up to 4)

3

※Dimensions and weights are based on 7-16 / 11.2-24.

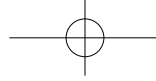

3-4 Designed for your world

Items		T3025 (CH)
3 Point Hitch	3 Point Hitch	CAT I
	Lift capacity at lift link ends lbs(kg)	3,306 (1,500)
	3Point Hitch Lift Capacity @24" behind lift point lbs(kg)	2,425 (1,100)
PTO	Rear PTO Speed RPM	540
	Rear PTO Type	Independent
	Clutch	Wet, Multi-disc
Tires	Front	7-16
	Rear	11.2-24
Dimensions	Wheelbase in. (mm)	65.7 (1,670)
	Overall Length(W/ 3PT) in. (mm)	120.9 (3,071)
	Min.Overall Width in. (mm)	55.6 (1,413)
	Overall Height(W/ ROPS) in. (mm)	88.0 (2,253)
	Ground Clearance(4WD) in. (mm)	12.9 (327)
	Min.Turning Radius(W/ Brake) feet (m)	9.02 (2.75)
	Turning Degree	45°
Weight(W/O Front Weights) lbs (kg)	3,410 (1,547)	

※Dimensions and weights are based on 7-16 / 11.2-24.

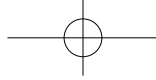

DRIVING SPEED

- ※ The tractor's speed is changed by the condition of the tires and road surface.
- ※ To ensure safety, drive at a proper speed.

Engine speed: 2,100 rpm, Tire rolling radius: 508 mm (Rear 11.2-24)

km/h (mph)

DIRECTION	RANGE SHIFT LEVER		
	A	B	C
FORWARD / REVERSE	3.94 (2.44)	10.03 (6.23)	19.4 (12.05)

3

Max travelling speed: 23.56 km/h (14.63 mph)

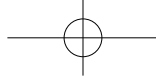

MEMO

A large, empty rectangular area with rounded corners, defined by a thin gray border, intended for writing a memo.

Designed for your world

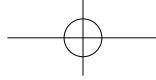

4. DESCRIPTION OF OPERATING SYSTEM

EXTERIOR VIEW 4-3

- MAIN (IGNITION) KEY SWITCH..... 4-5
- HAZARD SWITCH..... 4-5
- COMBINATION SWITCH 4-6
- ACCELERATOR LEVER 4-6
- CRUISE CONTROL SWITCH..... 4-7
- STEERING COLUMN TILT LEVER 4-8
- PARKING BRAKE LEVER 4-8

INSTRUMENT PANEL..... 4-9

- PTO LAMP..... 4-10
- LEFT/RIGHT TURN SIGNAL LAMP 4-10
- HIGH BEAM LAMP 4-10
- PARKING BRAKE LAMP..... 4-11
- ENGINE OIL PRESSURE WARNING LAMP 4-11
- BATTERY CHARGE WARNING LAMP 4-11
- PREHEAT LAMP 4-12
- FUEL GAUGE..... 4-12
- TACHOMETER 4-13
- HOUR METER 4-13

CONTROLS 1(PEDALS)4-14

- BRAKE PEDAL..... 4-14
- F-R SHUTTLE PEDAL..... 4-14

CONTROLS 24-15

- LEVER OPERATION..... 4-15
- LEVER(RH/LH) 4-15
- RANGE SHIFT LEVER 4-16
- POSITION CONTROL LEVER 4-16
- PTO SHIFT LEVER..... 4-16
- STEERING COLUMN TILT LEVER 4-17
- PARKING BRAKE LEVER 4-17
- PTO OPERATION SWITCH/PTO ON/OFF SWITCH... 4-18
- DIFFERENTIAL LOCK PEDAL 4-19
- FLOW CONTROL VALVE 4-19
- MFWD LEVER..... 4-20

Designed for your world

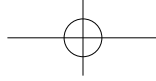

4. OPERATION DESCRIPTION

OTHERS4-20

WORK LAMP SWITCH 4-20

WIPER SWITCH..... 4-20

STEREO 4-21

CLIMATE CONTROL 4-22

SEAT BELT 4-23

SEAT ADJUSTMENT..... 4-23

BRAKE LAMP 4-24

Designed for your world

EXTERIOR VIEW

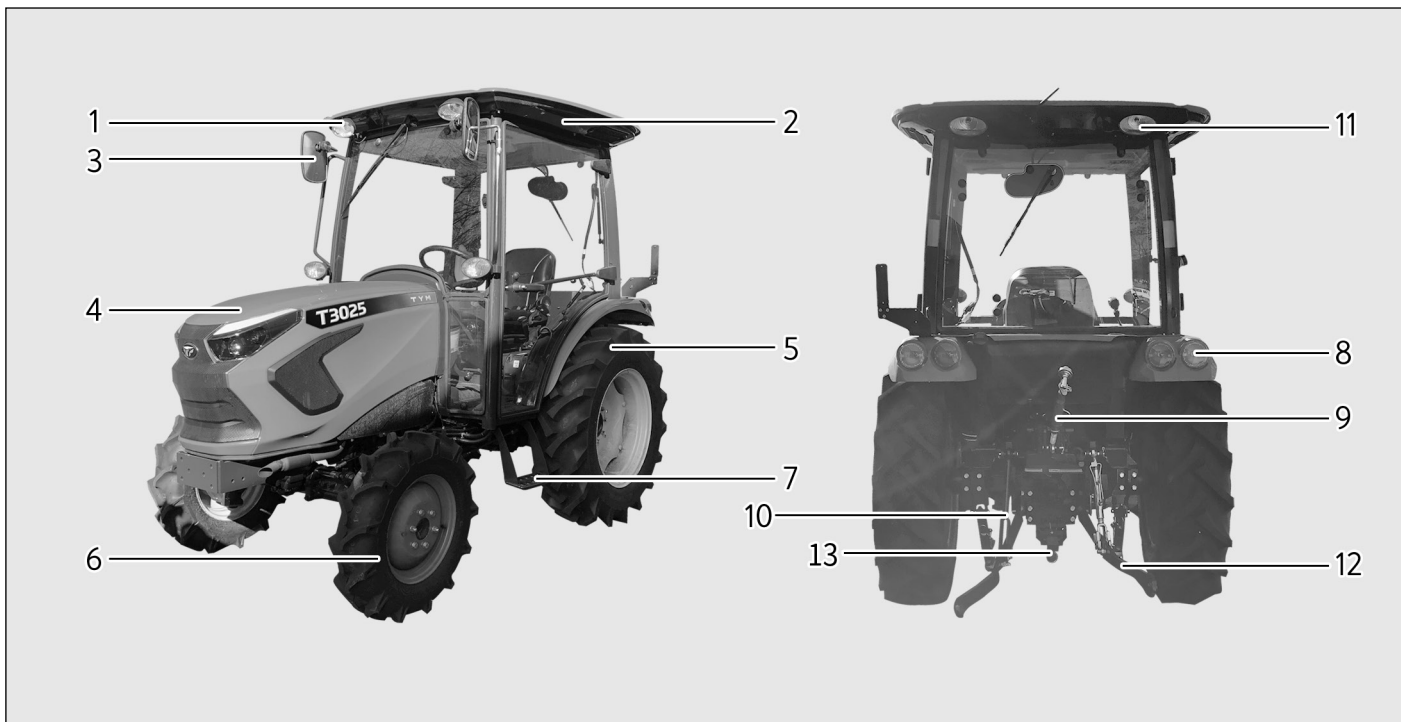

(1) Work Lamp (F)
 (2) Roof
 (3) Side Mirror
 (4) Hood

(5) Rear Tire
 (6) Front Tire
 (7) Step
 (8) Combination Lamp

(9) Top Link
 (10) Lift Rod
 (11) Work Lamp
 (12) Lower Link

(13) Draw Bar

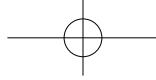

4-4 Designed for your world

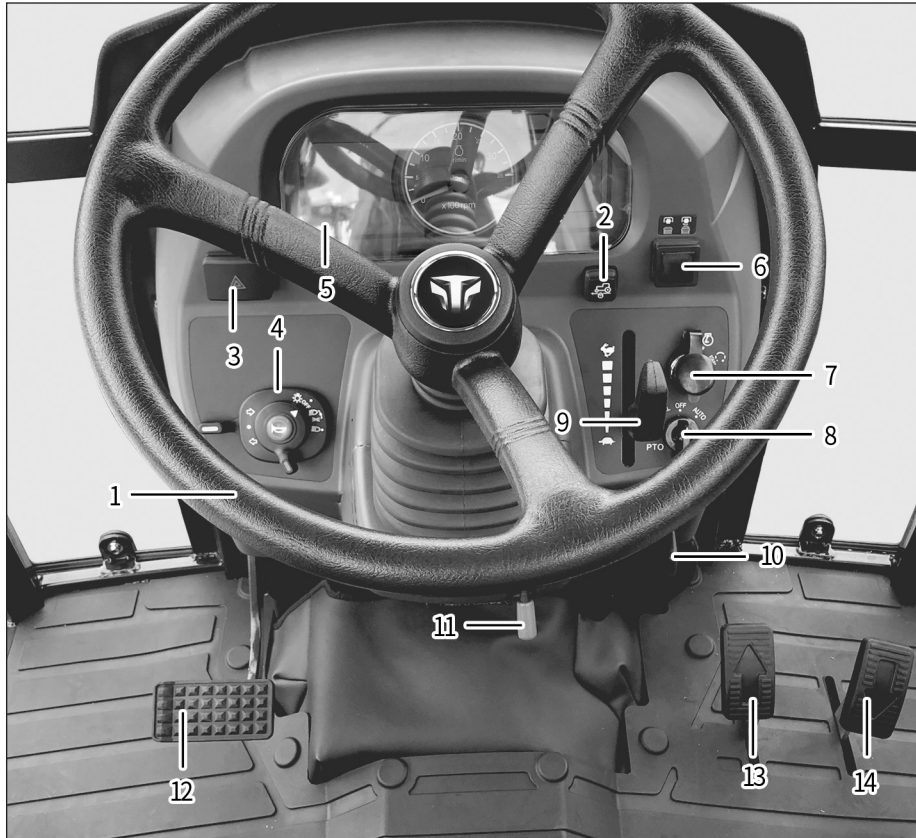

- (1) Steering Wheel (Handle)
- (2) Cruise Control Switch
- (3) Hazard Switch
- (4) Combination Switch
- (5) Instrument Cluster
- (6) PTO ON/OFF Switch
- (7) Main (ignition) key switch
- (8) PTO Operation Switch
- (9) Accelerator Lever
- (10) Parking Brake Lever
- (11) Steering Wheel Tilt Lever
- (12) Brake Pedal
- (13) Forward Shuttle Pedal
- (14) Reverse Shuttle Pedal

※ Refer to the relevant content for further detailed information

MAIN (IGNITION) KEY SWITCH

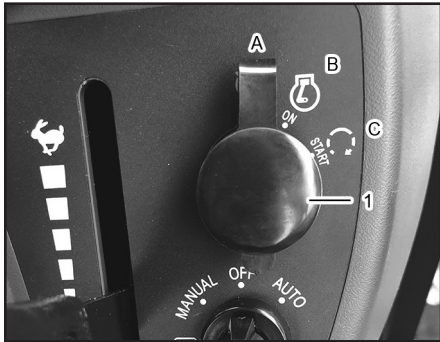

- (1) Main (ignition) key switch
 (A) OFF (B) ON
 (C) START

The main switch is used to start or stop the engine.

- **OFF:** The engine is stopped, and current ends at the main (ignition) key switch.
- **ON:** Electric current flows to all switches in the electrical system.
- **START:** When the starter motor is engaged, the engine will start. When the engine is started, release the key. The key will return to the “ON” position automatically and the engine will keep running.

CAUTION

- When the tractor is not in use, take out the key and keep it in a safe place.

HAZARD SWITCH

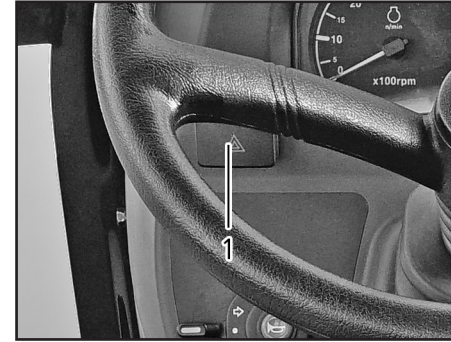

- (1) Hazard Switch

Press the hazard switch in emergency to warn other vehicles in order to prevent an accident.

Pressing this switch blinks all turn signal lamps regardless of the position of the main switch. Pressing it again disables the flasher function.



CAUTION

- Prolonged operation can consume electricity excessively. Therefore, use it only in emergency. Use it only when necessary as it can discharge the battery and obstruct other driver's view.

COMBINATION SWITCH

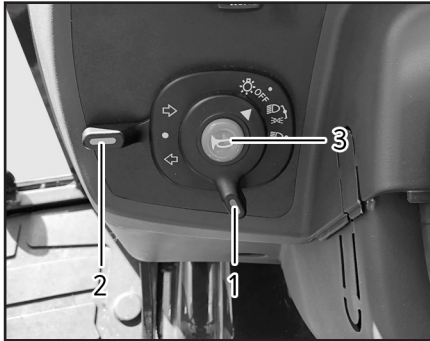

- (1) Lamp Switch
- (2) Turn Signal Lamp Switch
- (3) Horn Button

Turning the lamp switch clockwise to the first notch turns on the tail lamps and instrument cluster. Turning it further turns on the high/low beam.

Push up the turn signal lamp switch to turn on the right turn signal lamp and press down the switch to turn on the left turn signal lamp. To sound the horn, press the horn button in center of the switch.

ACCELERATOR LEVER

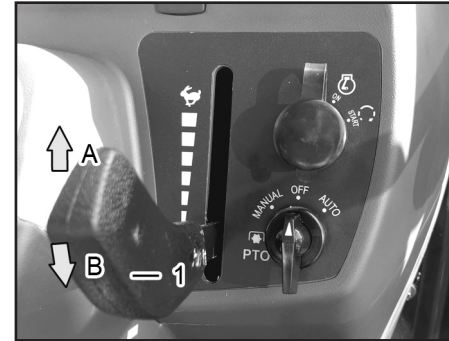

- (1) Accelerator Lever

- : Faster Engine RPM (A)
- : Slower Engine RPM (B)

It is used to make the engine run faster or slower. It is also used when working at a constant speed.

NOTE

- Use the accelerator pedal during driving for travel, not the accelerator lever.

CRUISE CONTROL SWITCH

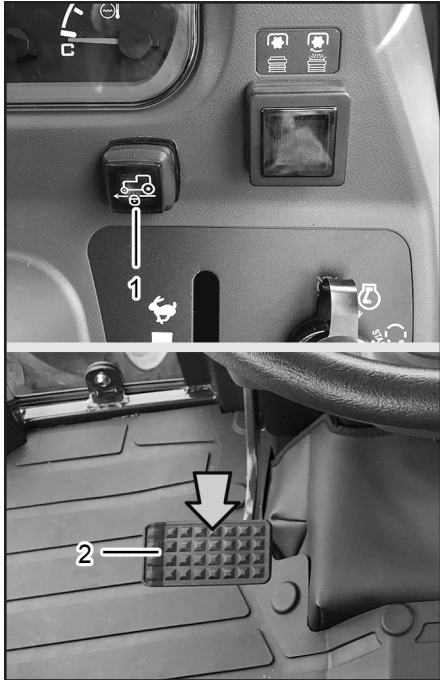

- (1) Cruise Control Switch
(2) Brake Pedal

1. When the machine has reached the desired speed, press cruise control switch to “ON”. Release the HST pedal and the machine will operate at the selected speed.
2. When applying full pressure to the Brake pedals, the cruise control will be deactivated and it will be necessary to reset the cruise control to the desired speed.
3. When applying light pressure to the Brake pedals, the machine’s ground speed will be reduced until the Brake pedals are released. At that point the machine will continue at the previous setting.
4. To reset the desired speed, you should turn off the cruise control switch then increase machine speed to reach the desired speed push cruise switch to on.

CAUTION

- When stopping the machine cruise control keep machine stop status.
- Make sure to connect both Brake pedals when using cruise control function.

[Otherwise]

There is a risk abrupt turning or over-turning due to one-sided Braking when the Brake pedal is depressed.

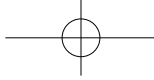

STEERING COLUMN TILT LEVER

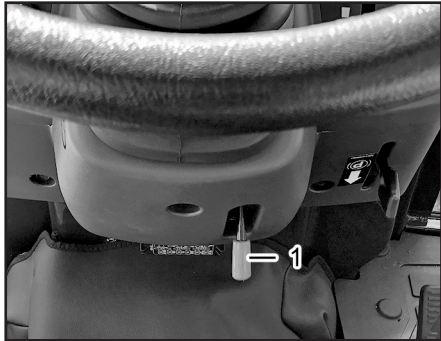

(1) Steering Column Tilt Lever

Confirm that the steering wheel is firmly fixed.

⚠ CAUTION

- Must not be adjusted while driving.

PARKING BRAKE LEVER

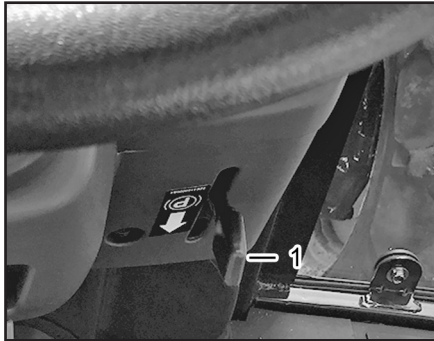

(1) Parking Brake Lever

After pressing the brake pedal, lower the brake lever to lock the brake.

INSTRUMENT PANEL

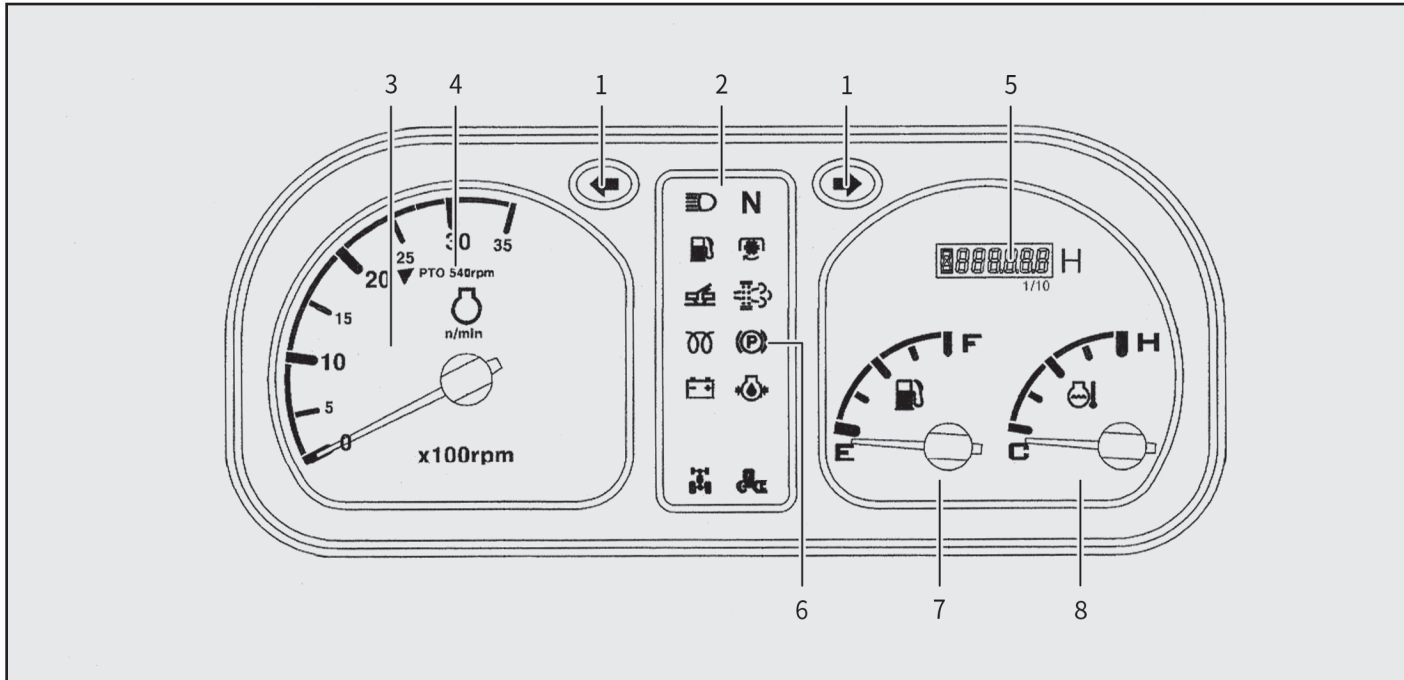

- (1) Turn Signal Lamp
- (2) Lamp - LED
- (3) Tachometer
- (4) PTO Rotating Position

- (5) Hour Meter
- (6) Parking Brake Lamp
- (7) Fuel Gauge
- (8) Temperature Warning Gauge



PTO LAMP

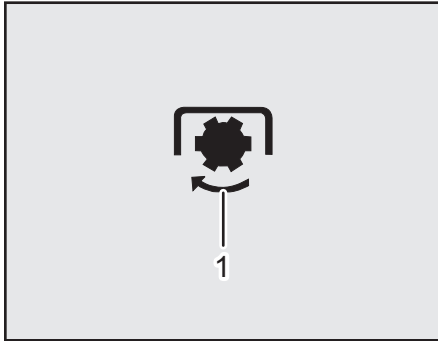

(1) PTO Lamp

This comes on while the PTO shaft is rotating.

LEFT/RIGHT TURN SIGNAL LAMP

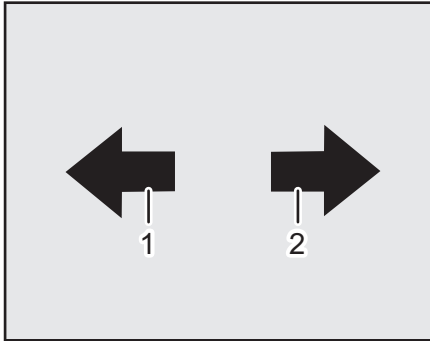

(1) Left Turn Signal Lamp
(2) Right Turn Signal Lamp

This indicates the condition when operating one of the turn signal lamps for the desired turning direction.

HIGH BEAM LAMP

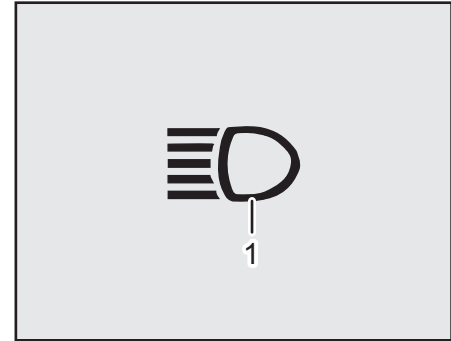

(1) High Beam Lamp

It indicates the high beam. Select the low beam for driving on a road.

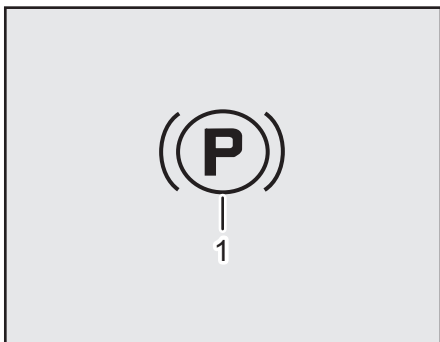
PARKING BRAKE LAMP

(1) Parking Brake Lamp

This comes on when the parking brake is applied or the brake pedal is depressed. [US] This comes on when the parking brake is applied only. [EU]

If the parking brake is applied, release the parking brake lever before driving.

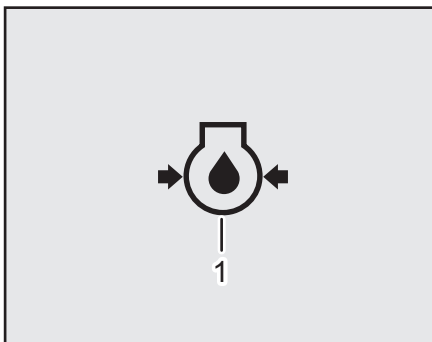
ENGINE OIL PRESSURE WARNING LAMP

(1) Engine Oil Pressure Warning Lamp

Lamp will come on when the ignition switch is put into the “ON” position. It will turn off when the engine is started. If this lamp comes on while the engine is running, it indicates a problem in the engine oil system. Stop the engine immediately and check for problems.

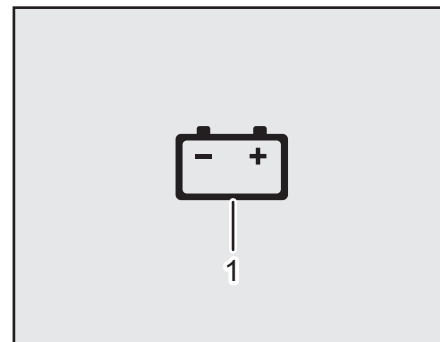
BATTERY CHARGE WARNING LAMP

(1) Battery Charge Warning Lamp

The battery charge warning lamp is turned on when the main (ignition) key switch is initially turned to the “ON” position before starting the engine but turned off after starting the engine. If this lamp comes on while driving, the charging system is malfunctioning. In this case, check the fan belt or ask your local dealer for further inspection if necessary.

PREHEAT LAMP

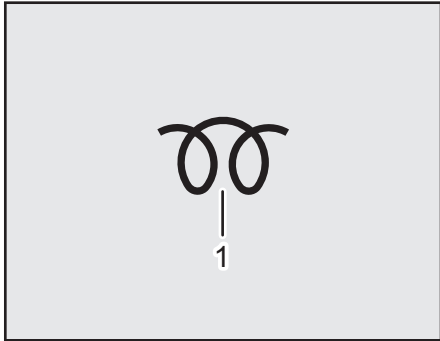

(1) Preheat Lamp

Lamp will light on/off depending on temperature of engine coolant when main (ignition) key switch is turned on.

Lamp will be turned off when heater coil is heated. Start engine after this lamp is turned off.

It is difficult to start engine in winter when starting engine before warm up lamp is turned off. It also causes early discharge of battery.

NOTE

- The time of pre-heating duration varies depending on the coolant temperature.

	Temperature	Time (sec.)
Lamp Time	above 104°F	less than 4
	5°F ~ 104°F	10
	less than 5°F	14

FUEL GAUGE

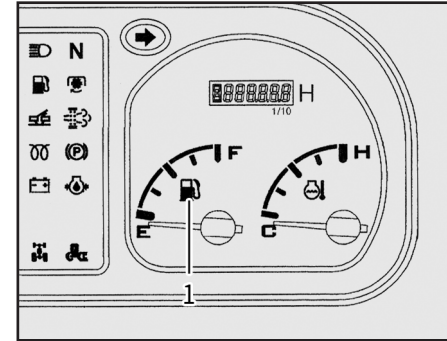

(1) Fuel Gauge

This indicates the remaining fuel level. Immediately fill the fuel tank if the needle reads the red area.

TACHOMETER

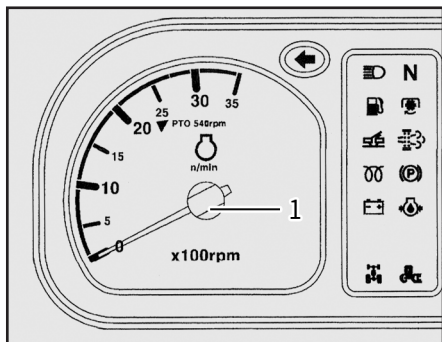

(1) Tachometer

The tachometer indicates the engine rpm.

HOUR METER

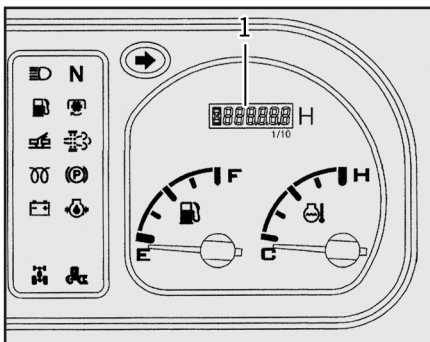

(1) Hour Meter

It indicates the tractor's running hours. By multiplying the digit in the far right position by 6, you will get the time in minute.

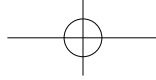

CONTROLS 1 (PEDALS) BRAKE PEDAL

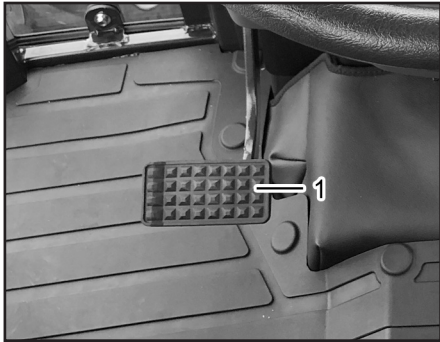

(1) Brake Pedal

It is used for decreasing travelling speed of the tractor or stopping the tractor.

F-R SHUTTLE PEDAL

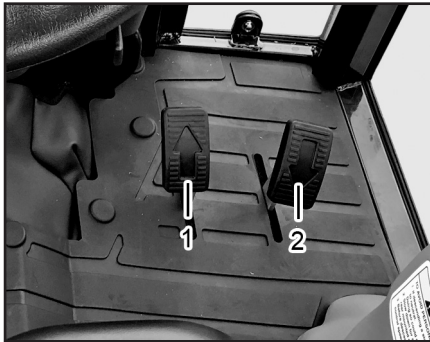

(1) Forward Shuttle Pedal
(2) Reverse Shuttle Pedal

It is used for shifting between “forward” and “reverse” drive. And stay pedals at neutral machine should be stopped.

WARNING

- For safety, do not shift quickly from “forward” to “reverse” or from “reverse” to “forward”. Engage Brake pedals when stopping the machine for machine to stop quickly.

CONTROLS 2 LEVER OPERATION



- (1) Joy-Stick Lever
- (2) Range Shift Lever
- (3) PTO ON/OFF Switch
- (4) PTO Operation Switch
- (5) Parking Brake Lever

LEVER(RH/LH)

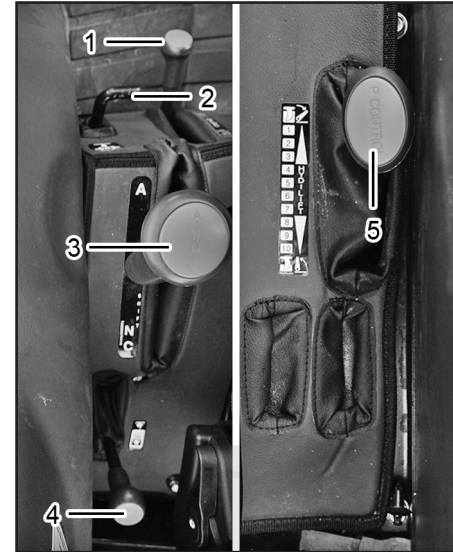

- (1) MFWD Lever
- (2) Differential Lock Pedal
- (3) Range Shift Lever
- (4) PTO Shift Lever
- (5) Position Control Lever

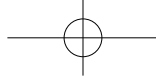

RANGE SHIFT LEVER

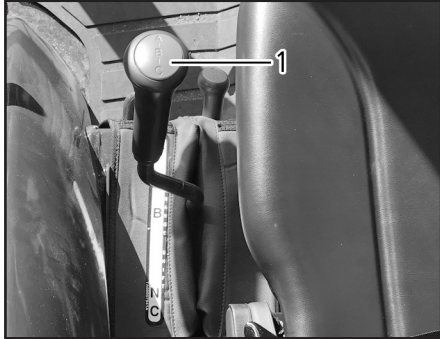

(1) Range Shift Lever

The range gear is shifted in three levels (A-B-C).
When shifting the range gear, stop tractor.

POSITION CONTROL LEVER



(1) Position Control Lever

It is used to keep the implement constantly at a certain position. A stopper is used to fix the position control lever in the “UP” position while driving on a road.

When lowering the implement, set the position control lever, and the implement will go down to the set position.

PTO SHIFT LEVER



(1) PTO Shift Lever

The revolution of the PTO shaft can be shifted in two levels. When shifting lever, Put PTO switch to “OFF” position.

STEERING COLUMN TILT LEVER

⚠ CAUTION

- Observe the PTO speed designated on the implement. Otherwise, the implement may be damaged and cause an accident.

⚠ WARNING

- To avoid personal injury, Confirm that no one or a foot is under the implement before operating the system.

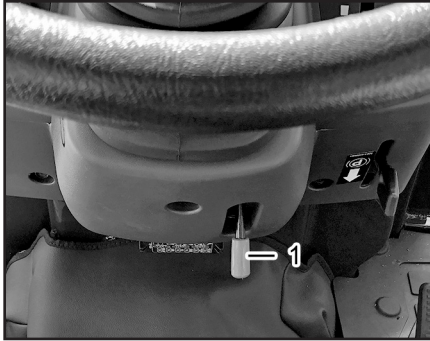

(1) Steering Column Tilt Lever

Confirm that the steering wheel is firmly fixed.

⚠ CAUTION

- Must not be adjusted while driving.

PARKING BRAKE LEVER



(1) Parking Brake Lever

After pressing the brake pedal, lower the brake lever to lock the brake.

PTO OPERATION SWITCH/PTO ON/OFF SWITCH

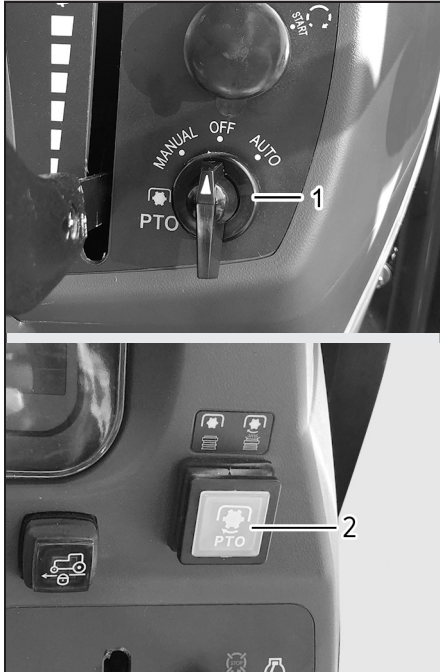

(1) PTO Operation Switch
(2) PTO ON/OFF Switch

▶ PTO OPERATION SWITCH

- [MANUAL]
In the MANUAL position, the PTO shaft rotates constantly regardless of the position of the rear implement.
- [OFF]
The PTO shaft is stopped.
- [AUTO]
In the AUTO position, the PTO shaft stops rotation when the rear implement is lifted to a certain level. The PTO shaft rotates again as soon as the rear implement is lowered.

▶ PTO ON/OFF SWITCH

- [ON]
When pressing the switch, the red lamp comes on and the PTO shaft rotates.
- [OFF]
When pressing the switch again, the lamp goes off and the PTO shaft stops rotating.

DIFFERENTIAL LOCK PEDAL

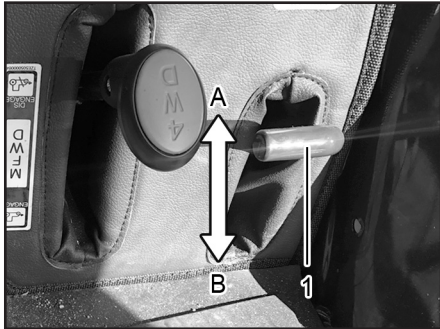

(1) Differential Lock Pedal
(A) Release (B) Engage

The differential lock pedal is to keep the wheel rotation on both sides the same when one of the rear wheels is idling or spinning without traction. Be sure to use the steering wheel only while the wheels are set in a straight ahead position. Otherwise, the differential system may be damaged.

WARNING

- Be sure to release the differential lock before making a turn.

FLOW CONTROL VALVE

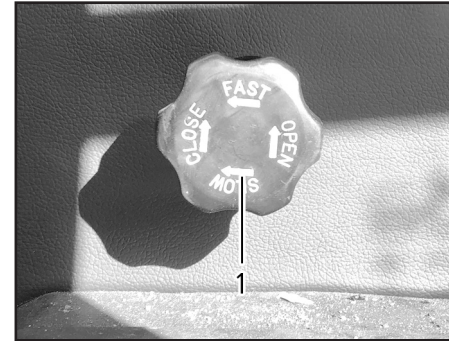

(1) Flow Control Valve

It is used to regulate the lowering speed of the implement (slow return function). Also, if you wind the valve fully to the right, the hydraulic pressure to the device raising the implement is stopped.

MFWD LEVER



(1) MFWD Lever

It is used to shift between 2-wheel drive and 4-wheel drive.
Stop the tractor before shifting the lever.

OTHERS WORK LAMP SWITCH

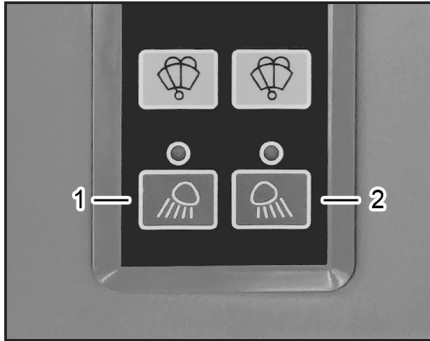

(1) Work Lamp Switch (FR)
(2) Work Lamp Switch (RR)

The front and rear working lights are “ON” when push the button. The work lamp on the instrument cluster will illuminate.

WARNING

- Working lamp must be Turned “OFF” while driving at night, or any sudden accidents may occur.

WIPER SWITCH

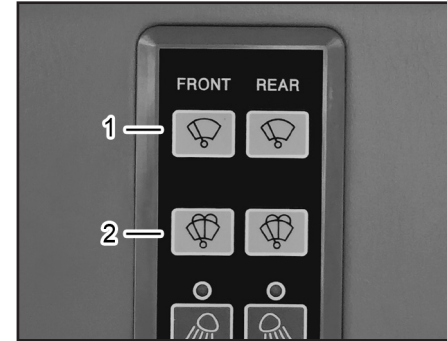

(1) Wiper Switch
(2) Wiper Switch(Washer)

▶ “ON” SWITCH

- Wind screen wiper operation.
- Continuous pushing button operates wiper and washer pump.

▶ “OFF” SWITCH

- Wind screen wiper “OFF” and operates washer pump.



(1) Washer Fluid Inlet

Check the level of windscreen washer fluid in the plastic reservoir located on the rear side of tractor.

During winter it is advisable to add a suitable antifreeze or methyl alcohol to the windscreen washer fluid.

⚠ CAUTION

- Do not use the wiper when the washer fluid reservoir is empty, otherwise you will damage the wiper pump.
- Do not use the wiper if there is any danger that the fluid will freeze on the wind-shield. If you do, your vision could be obscured. For this reason, use antifreeze.

STEREO



(1) Stereo

This is used to listen to MP3 or radio.

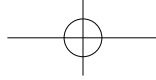

CLIMATE CONTROL

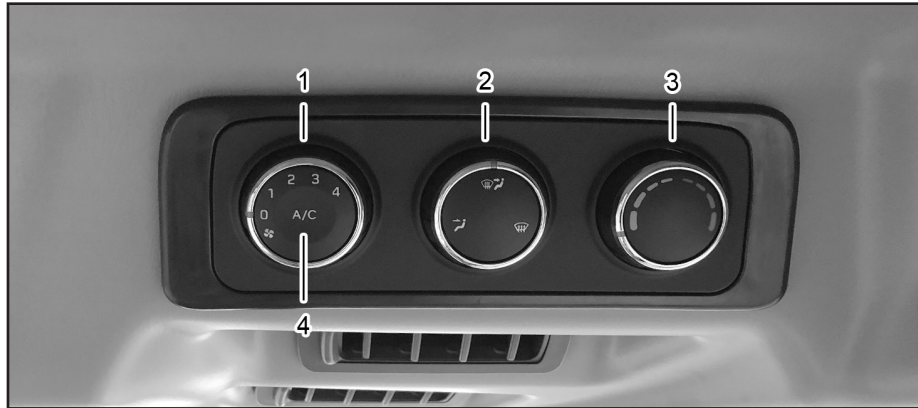

(1) Air Flow Rate (2) Air Circulation Control (3) Temperature (4) Cooling Function

► COOLING FUNCTION

When the cooling function is on, the air compressor is worked, then reheated according to the temperature setting.

► AIR FLOW RATE

Adjust the air flow rate. The higher the rate, the more effective the heating or cooling will be.

► AIR CIRCULATION CONTROL

It is used to change the direction of the wind.

► TEMPERATURE:

Red, to increase the temperature.
Blue, to decrease the temperature.

SEAT BELT



(1) Seat Belt

⚠ WARNING

- Do not wear the seat belt when the safety frame is folded down. With the frame folded down, it does not provide safety.
- When operating the tractor, make sure to keep the safety frame in the upright position and wear the seat belt.

SEAT ADJUSTMENT

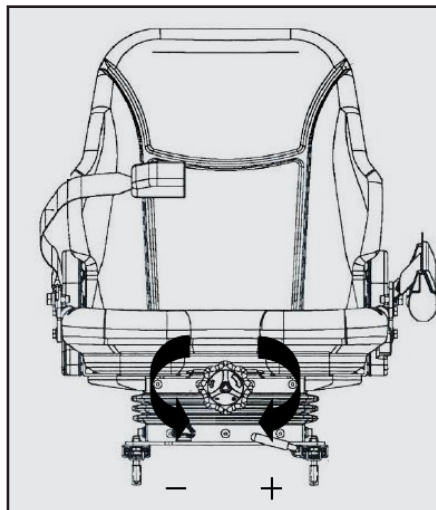

► **FORE AND AFT POSITIONING**

Lift handle and move the seat forward or rearward. Release the handle at one of several positions.

► **BACK CUSHION ANGLE ADJUSTMENT**

Lift the handle and let the back cushion spring forward, or lean backward into the cushion. Release the handle at desired position.

► **WEIGHT ADJUSTMENT**

With seat in mid-position, extend the crank lever from knob and rotate minus(-) direction for less support or Plus(+) for more support. Use the Lamp for approximate weight setting. Release crank lever.

⚠ CAUTION

- Never attempt to adjust your seat while the tractor is moving. The seat could respond with unexpected movement, and the ensuing loss of tractor control could lead to an accident.

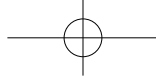

BRAKE LAMP

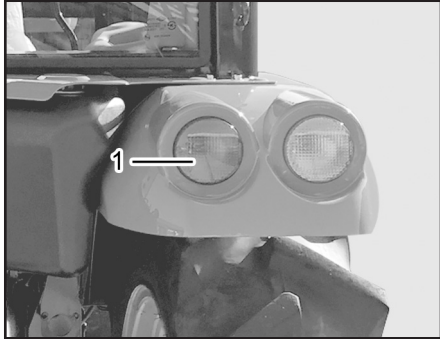

(1) Brake Lamp

It is turned on when the Brake pedal is depressed.



5. OPERATION

DAILY INSPECTION BEFORE STARTING	5-2	ATTACHMENT OF IMPLEMENT	5-14
PRE-OPERATION CHECK.....	5-2	ATTACHMENT POSITION	5-14
PRE-OPERATION	5-2	TOP LINK ADJUSTMENT	5-15
BEFORE STARTING THE ENGINE	5-2	ATTACHING IMPLEMENT.....	5-15
RUNNING-IN PERIOD	5-3	ADJUSTMENT OF CHECK LINK	5-17
STARTING ENGINE	5-3	ADJUSTMENT OF VERTICAL HEIGHT.....	5-17
HOW TO START	5-3	POSITIONING OF DRAW BAR	5-18
COLD START	5-6	INSTALLATION OF PTO DRIVEN IMPLEMENT	5-18
STOPPING ENGINE.....	5-6	TIRES, WHEELS AND BALLAST	5-19
TRACTOR OPERATION	5-6	TIRE TYPE.....	5-19
WHEN ATTACHING WEIGHT.....	5-6	WHEEL AND AXLE.....	5-20
REDUCE SPEED WHEN TOWING LOAD.....	5-7		
HOW TO DRIVE.....	5-7		
STOPPING	5-10		
PARKING.....	5-11		
DIFFERENTIAL LOCK.....	5-12		
POSITION CONTROL LEVER	5-13		

Designed for your world

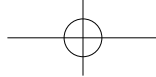

5-2 Designed for your world

DAILY INSPECTION BEFORE STARTING

1. Check the engine oil level.

After wiping out the dipstick, insert it fully and then withdraw it. Oil should be between the two marks on dipstick.

Do not operate the engine if oil level is below minimum mark. If below, add the corresponding grade oil according to the season through the filler.

2. Feed grease to all greasing points indicated below every 10 hours when working in damp and muddy conditions.
 - Front axle pin
 - Steering shaft and Cylinder end
 - Tie rod both ends
 - Front axle supporter
3. After cleaning the machine with highly pressurized water, lubricate the indicated points with grease below if necessary.
 - Bonnet latch
 - Seat sliding rail

PRE-OPERATION CHECK PRE-OPERATION

Check the engine operation carefully.

⊕ IMPORTANT

- **The engine is tuned or set for normal use. In case of a new tractor, especially carry out inspection and check within first 100 hours.**
- Be sure to warm up the engine. Inspect the battery charge warning lamp, oil pressure warning lamp and engine coolant temperature gauge.
- Avoid any unnecessary engine idling.
- Frequently check the engine oil, coolant, transmission fluid and front axle oil levels. Also, inspect for leakage of those fluids.

NOTE

- **Make sure to add the corresponding grade oil for the season. Use only genuine oil specified by TYM.**

BEFORE STARTING THE ENGINE

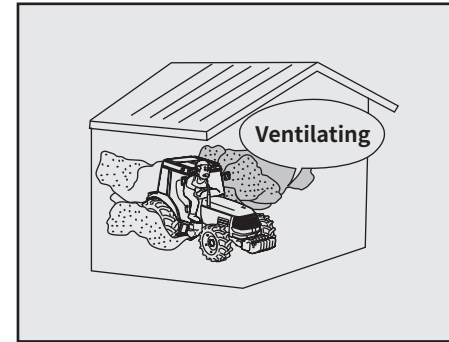

⚠ CAUTION

- **Avoid running the engine in an enclosed area. Exhaust gas can be very harmful to your health. If it is unavoidable to run the engine in an enclosed area, extend the exhaust pipe to the outside to release exhaust gas to the atmosphere.**



RUNNING-IN PERIOD

⊕ IMPORTANT

- Always keep wheel bolts tightened to prevent any accident. Confirm that the wheel bolts are tight before operation. Check wheel bolt torque at least twice within the first 10 hours of operation, check it periodically at every 50 hours thereafter. Change the oil and filter after first 50 hours of operation.

▶ Within first 10 hours of operation

- Inspect daily or every 10 hours
- Tighten the wheel bolts

▶ After first 50 hours of operation

- Tighten the wheel, disc and hub bolts
- Check the alternator and fan belt tension as well as air inlet
- Tighten the cooling system's hose and clamp
- Perform the scheduled 50-hour maintenance
- Change the transmission/hydraulic oil and oil filter element
- Change the engine oil and filter
- Change the front axle fluid

STARTING ENGINE HOW TO START

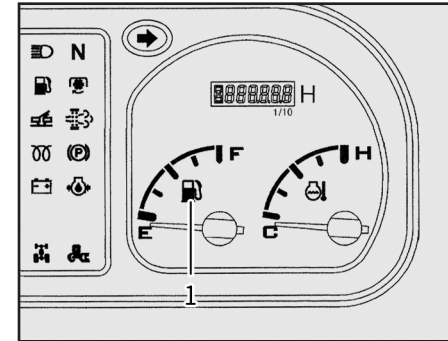

(1) Fuel Gauge

1. Check the fuel gauge. Make sure that a sufficient amount of fuel is in the tank.



5-4 Designed for your world

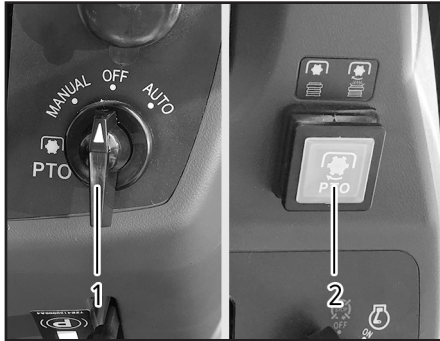

- (1) PTO Operation Switch
- (2) PTO ON/OFF Switch

2. Confirm that the PTO Operation Switch is set in the “OFF” position. If not, the engine won’t be started. Turn the PTO switch to OFF.



- (1) Position Control Lever

3. Check the position of the implement. Push the control lever forward to lower the implement down onto the ground.

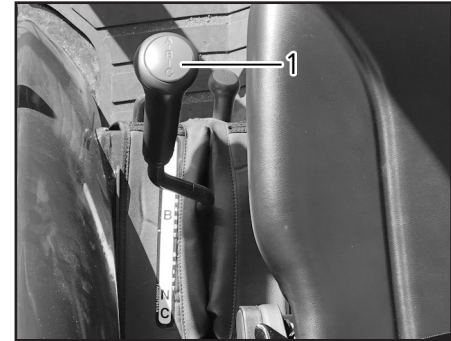

- (1) Range Shift Lever

4. Put the range shift lever in the “Neutral” position.

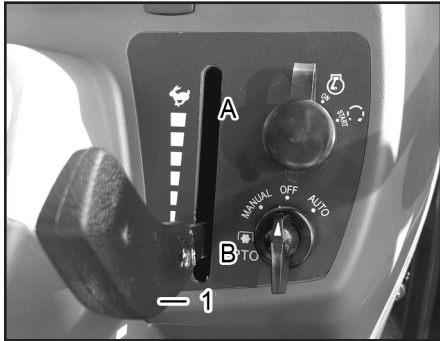
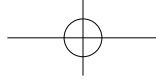

(1) Accelerator Lever



Max.



Min.

- Place the accelerator lever to the Minimum position.

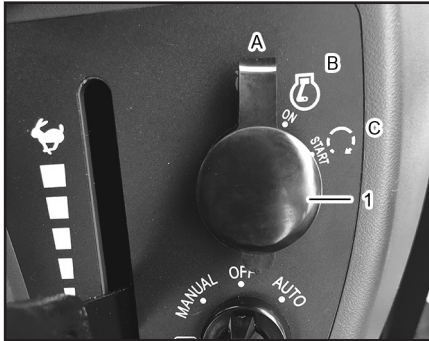

(1) Main (ignition) key switch

(A) OFF

(B) ON

(C) START

- Turn the main (ignition) key switch to the "START" position. When the engine is started, take your hand off the key.

⊕ IMPORTANT

- Do not operate the start motor more than 20 seconds at a time. If the start motor won't start, wait until the motor is cooled down at least for 2 minutes and then try again.

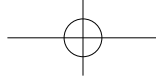

COLD START

CAUTION

- In case of the tractor equipped with the cold start system, do not use starting fluid.

1. When starting in cold weather, turn the main (ignition) key switch to the “ON” position and then wait until the preheat indicator is turned off.
2. For safe operation, turn the main (ignition) key switch to the “START” position without the forward shuttle pedal or reverse shuttle pedal depressed.
3. Repeat the above procedures until the engine is operated smoothly.
4. Let the engine idle at 1,200 rpm to warm up the engine up to the operating temperature.

STOPPING ENGINE

Make sure to reduce the engine rpm with the accelerator lever in the low speed position before stopping the engine. Put all shift levers in the “National” position.

And then turn the main (ignition) key switch to the “OFF” position to stop the engine.

TRACTOR OPERATION WHEN ATTACHING WEIGHT



CAUTION

- Do not drive on a road under a heavily loaded condition. Otherwise, it can lead to an injury or machine damage.

1. Reduce the speed when driving on a bumpy or rough ground.
2. Attach the additional weight needed for stability and safe cornering if required.
3. Make sure that the front wheels are not risen up when transporting implements or towing a heavy load.



REDUCE SPEED WHEN TOWING LOAD

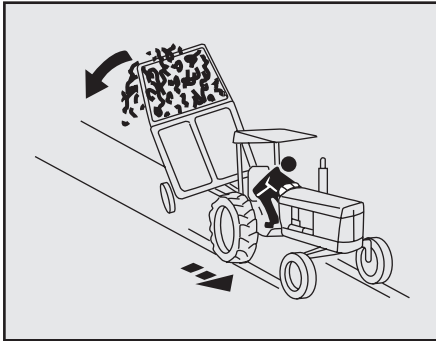

CAUTION

- The stopping distance becomes longer on a downhill in proportion to the speed and load weight. If the towed weight is heavier than the tractor and the braking system is not installed on the trailer, reduce the speed. Observe the guideline for towing speed and capacity.

Observe the guideline for towing speed and capacity as below.

1. If the trailed weight is the same or lighter than the tractor, maintain the maximum speed of 26 km/h.
2. If the trailed weight is twice the tractor or less, maintain the maximum speed of 13 km/h.
3. If the trailed weight is more than twice the tractor, do not tow it.
4. Be careful especially when towing a load on a bad condition of ground, slope or corner.

HOW TO DRIVE

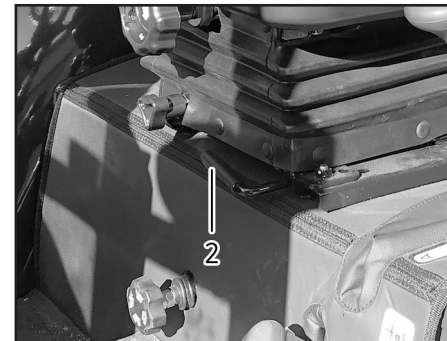

(1) Seat Belt

(2) Seat Sliding Lever

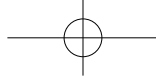

5-8 Designed for your world

1. Adjust the seat properly and fasten the seat belt. Adjust the seat to easily reach the pedal and the steering wheel. If the seat belt is worn across the abdomen or waist, not the hips, an injury can occur in case of an accident or impact. Adjust the levers properly according to the driver's physical condition.

CAUTION

If the tractor is out of control, it can cause a personal injury or even death. Keep the following instructions on a road:

- Use the accelerator pedal.
- Reduce the speed while driving on a slippery, or gravel road.
- Attach the proper weight.
- When reducing the speed, use the brake gently and carefully.

IMPORTANT

- Don't put a foot on the brake pedal unnecessarily during driving. Such action can reduce the brake's service life.

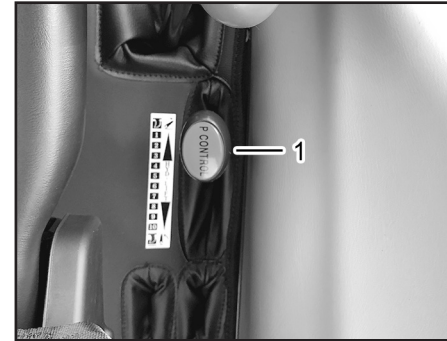

(1) Position Control Lever

3. Lift the implement.

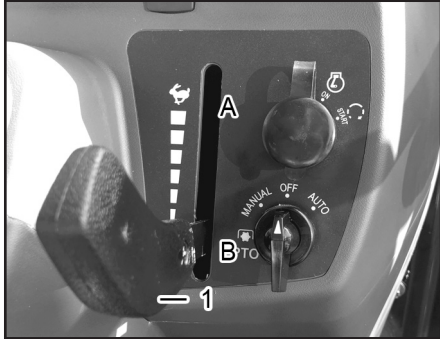
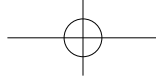

(1) Accelerator Lever
 (A) Max (B)  Min

4. Control the accelerator lever. Increase the engine rpm from low to high speed gradually.



(1) Parking Brake Lever

5. After pressing the brake pedal, lower the brake lever to lock the brake.



(1) Range Shift Lever

6. Put the range shift levers into the proper positions as the operator's intention.

 **CAUTION**

- The range shift lever should be operated while the vehicle is stationary. If not, there is a risk of machinery damage.

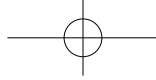

5-10 Designed for your world

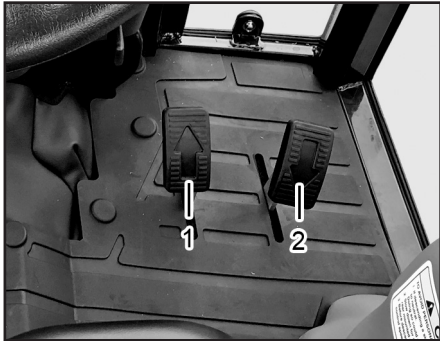

(1) Forward Shuttle Pedal
(2) Reverse Shuttle Pedal

7. Operate the forward or reverse shuttle pedal. Travelling speed can be adjusted by amount of depressing the pedals.

CAUTION

- Do not change the tractor speed abruptly for safe driving.
- Be careful of all directions of the tractor before driving. If not, it can cause an accident.
- When driving on a steep slope or moving to a location for loading or unloading, make sure to place the lever in the low speed position in advance.

STOPPING

1. Stop the tractor with the brake pedal.
2. Put the range shift lever to the “Neutral” position.
3. Put all SCV levers to the “Neutral” position.
4. Set the PTO switch in the “OFF” position.
5. Lower all implements on the ground.
6. Push the accelerator lever back slowly to decelerate the engine and keep the engine for 1 - 2 minutes of unloaded idling.
7. Make sure the parking brake is applied.
8. Turn the main (ignition) key switch to the “OFF” position to stop the engine.



PARKING

⊕ IMPORTANT

- The tractor needs to be stationary before making a shift. If the parking brake is applied while the tractor is moving, the transmission can be damaged.
- Each part of the engine is cooled down by the engine oil. If the hot engine is suddenly stopped, its high temperature or insufficient lubricant can cause damage to the related parts.

⚠ CAUTION

- Remove the ignition key before leaving the tractor to prevent its use by an unqualified person.



(1) Parking Brake Lever

1. Depress the brake pedal with a foot firmly and pull up the parking brake lever to lock the pedals.
2. To release the parking brake, depress the brake pedal firmly.

⚠ CAUTION

- The brake disc can be rapidly worn if you drive with the parking brake applied. To park the vehicle, apply the parking brake and then place prop under the rear wheels.



DIFFERENTIAL LOCK

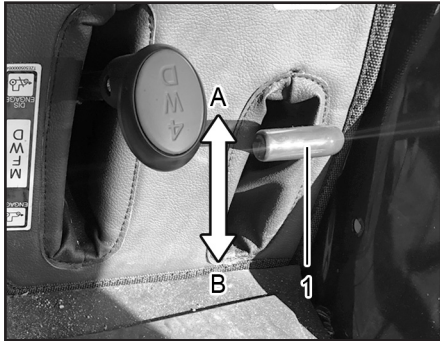

(1) Differential Lock Pedal
(A) Release (B) Engage

1. When the speed at one wheel starts to drop, depress the differential lock pedal to activate the differential lock.
2. If the wheel traction resistance on both wheel is not even, the differential lock keeps being engaged. While both wheel traction resistance is even, the differential lock is automatically disengaged. If the differential lock is not disengaged, depress one and another brake pedal separately.

3. If the tire is rotating idle repeatedly, try to engage the differential lock again.

CAUTION

- Do not drive the tractor at high speed or make a turn with the differential lock engaged.

IMPORTANT

- To prevent the power train from damage, do not press the differential lock pedal when one wheel is spinning fast and the other wheel is stopped.

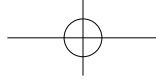

POSITION CONTROL LEVER

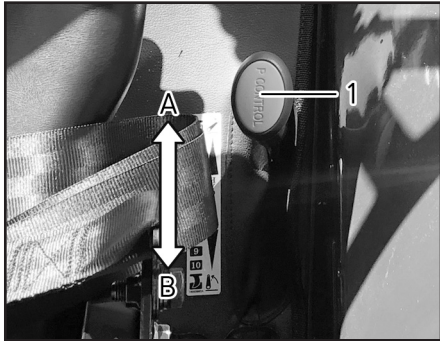

(1) Position Control Lever
(A) Lowering (B) Lifting

1. This position control lever can be used to lower and lift an implement freely.
2. Pulling the lever back lifts the implement while pushing it forward lowers the implement.

CAUTION

- To avoid a personal injury, use the position control lever when attaching/detaching the implement.

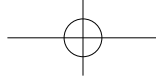

ATTACHMENT OF IMPLEMENT ATTACHMENT POSITION

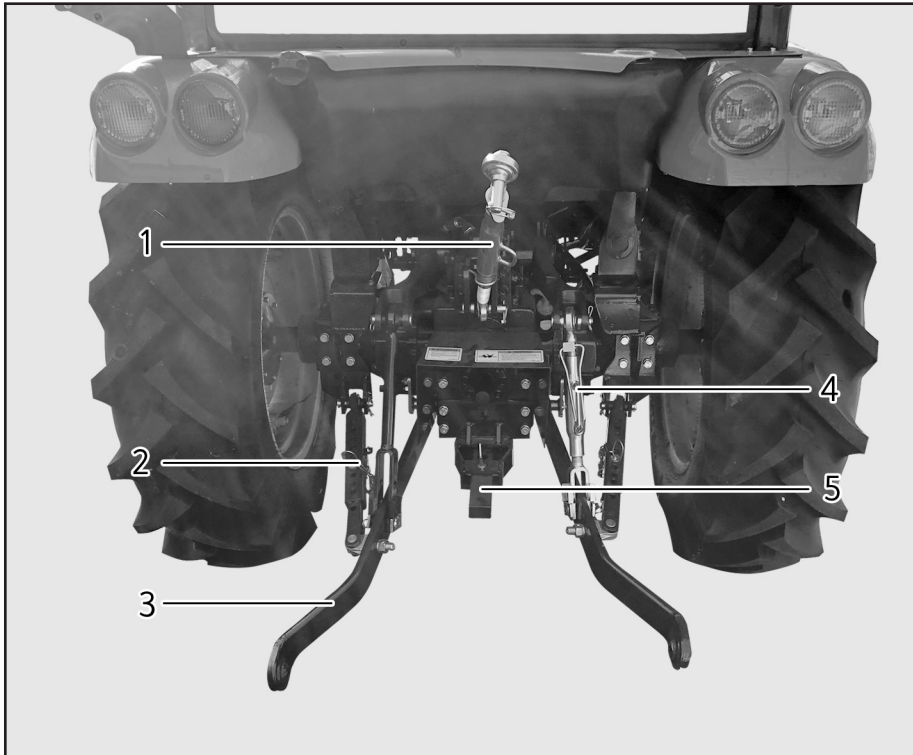

(1) Top Link
(2) Check Linkr

(3) Lower Link
(4) Lift Rod

(5) Draw Bar

CAUTION

Select an implement to match the tractor horse power;

The tractor horse power should correspond with the size of an implement. If the power level of tractor is exceeded, the implement may be damaged. Also, if the implement is too big, the tractor may be damaged. Be sure of the maximum and minimum power of the tractor before attaching an implement.

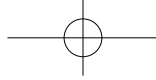

TOP LINK ADJUSTMENT

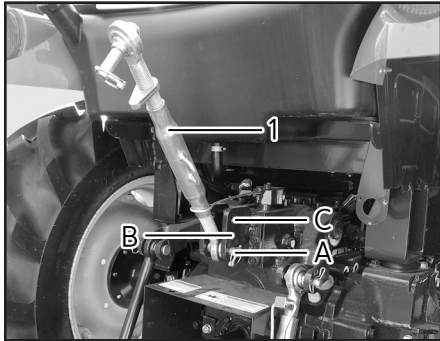

(1) Top Link (A) High Traction
(B) Mid Traction (C) Low Traction

The Top link can be installed to 3 selective positions according to the working condition.

A: If the Top link is attached to the bottom position, the draft system will be activated with highest sensitivity which is suitable for the implement such as a plow or equivalent which requires traction force.

B: The center hole is the standard installation hole for a rotary tiller.

C: If the Top link is attached to the top position, the draft system will not be activated. Therefore, it is good for the implement such as a drilling machine or equivalent which does not require any traction force.

ATTACHING IMPLEMENT

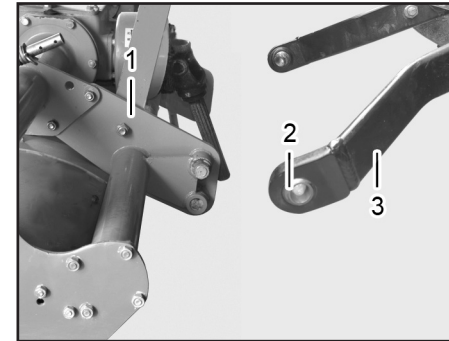

(1) Implement (2) Ball
(3) Lower link

1. Drive the tractor backward to move close to an implement to fit the position of 3-point hitch.
2. Apply the parking brake and stop the engine.
3. After inserting the hitch pins of the implement into the lower links, secure it with the lock pin.

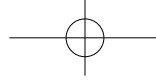

5-16 Designed for your world

WARNING

- To prevent the rocker shaft from unexpected movement, turn “OFF” the traction (draft) control before attaching the implement to the hitch.

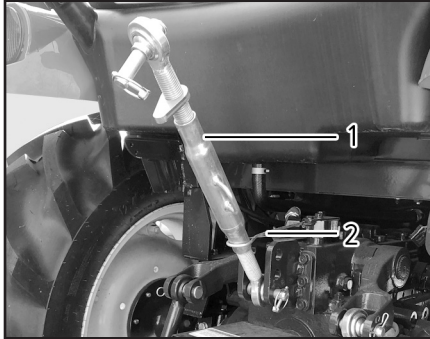

(1) Top Link

(2) Fixing Bracket

CAUTION

- Always check if there's no interference with the implement, quickcoupler of the implement, and other attachments when attaching to the 3-point hitch to avoid fatal personal injury or machinery damage.

4. Detach the Top link from the fixing bracket.
5. Attach the Top link to the top mast of the implement.
6. Adjust the length of the Top link and lower link if required.

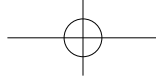

ADJUSTMENT OF CHECK LINK

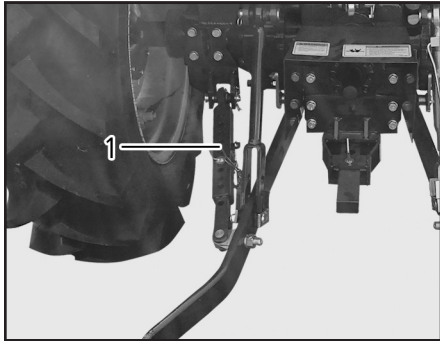

(1) Check Link

1. For implements such as a plow and disc harrow, adjust the length so that it can be moved for 5 - 6 cm sideways.
2. For implements such as a rotary tiller and mower, adjust the length so that it cannot be swayed sideways.

ADJUSTMENT OF VERTICAL HEIGHT

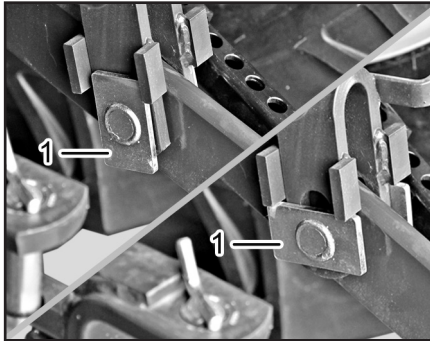

(1) Rectangular Steel Plate

1. To let the implement float along contour of the ground, turn the rectangular steel plate to the vertical position.
2. To secure the implement, turn the rectangular steel plate to the horizontal position.

⊕ IMPORTANT

- Do not extend the Top link excessively out of the limit. The Top link's body or thread can be damaged.

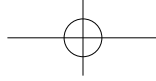

POSITIONING OF DRAW BAR

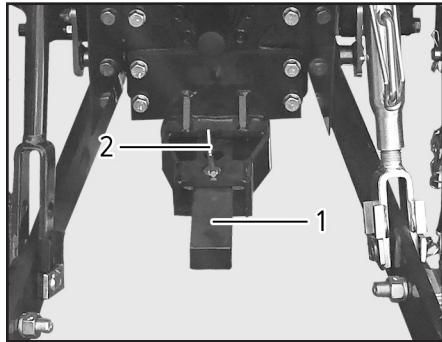

(1) Draw Bar (2) Lock Pin

Make sure to use the drawbar when towing the implement such as a trailer. In case of using the 3-point hitch (PTO drive), retract the draw bar to its shortest position and secure it.

The draw bar is adjusted in 2 stages.

1. Hold the draw bar and pull out the lock pin from the bracket.
2. Move the draw bar front and back to fit the lock pin.

3. When towing a heavy load, tow it with shortest draw bar position.

INSTALLATION OF PTO DRIVEN IMPLEMENT

1. Attach the implement to the tractor.
2. Lift the implement off the ground.
3. Stop the engine and put the PTO shift lever in the “Neutral” position.
4. After opening the PTO cover, connect the universal joint shaft while turning the PTO shaft by hand so as to align the splines.
5. To check the PTO shaft is secured, check if the pin is returned to the original position by pulling the universal joint shaft.
6. Close the PTO cover.
7. Adjust the PTO shift lever according to the working speed.
8. Check if the safety shields are in place and working environment is normal. If the master safety shield is not installed, do not operate the PTO. Stop the engine to check the PTO shaft and its guards Repair or lubricate if required.
9. The PTO shaft should not be interfered by any surrounding parts.

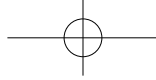
**CAUTION**

- If someone is entangled in the rotating part, it can cause a fatal injury. Always wear protective gear and install the safety shields and guards to the drive line. Don't wear loose clothing.
- Do not remove the installed protective cover of the PTO drive shaft without permission. If working with this protective cover removed, it can cause a severe injury. Refer to the warning decal on the cover.

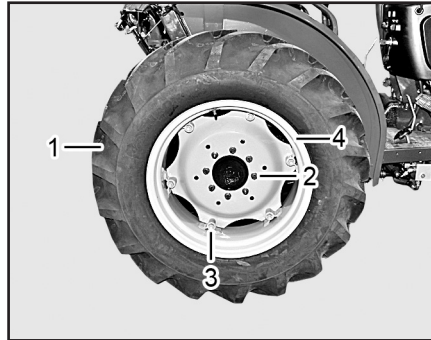
**TIRES, WHEELS AND BALLAST
TIRE TYPE**

- (1) Tire (2) Wheel Nut
(3) Rim bolt (4) Rim

Though the tire pressure is factory set to the prescribed level, it naturally drops slowly in the course of time. Thus, check it everyday and inflate as necessary.

PROPER INFLATION PRESSURE

		Tire size	Inflation pressure (kg/cm ²)
With rotary tiller	Front wheel	7-16	2.0
	Rear wheel	11.2 - 24	1.3
With loader	Front wheel	7-16	3.0
	Rear wheel	11.2 - 24	2.0

TIGHTENING TORQUE

	Specification
Wheel & axle mounting bolt	167 - 206 N.m (17 - 21 kgf.m)
Wheel rim and disc mounting bolt	167 - 206 N.m (17 - 21 kgf.m)

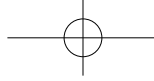

WHEEL AND AXLE

If the wheel or axle is loosened, tighten to the specified torque.

1. Drive the tractor about 100m and tighten it to the specified torque.
2. Inspect the wheel and axle every 10 hours of engine run or every 3 hours of working.
3. Inspect all wheels and axles frequently and securely tighten if necessary.



CAUTION

- **Never operate the tractor with a loose rim, wheel, hub or axle.**

NOTE

- **When operating a new tractor or when removing the wheel, follow the procedures above.**

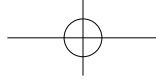

6. MAINTENANCE

MAINTENANCE SCHEDULE CHART 6-2

FLUIDS..... 6-4

FLUIDS AND CAPACITY..... 6-4

ROUTINE MAINTENANCE..... 6-5

OPENING HOOD..... 6-5

CHECKING AND REPLACING ENGINE OIL 6-5

CHECKING AND CHANGING TRANSMISSION OIL 6-6

CHECKING AND CHANGING FRONT AXLE OIL..... 6-7

REPLACING ENGINE OIL FILTER 6-7

REPLACING TRANSMISSION OIL FILTER 6-8

CHECKING AND CHANGING COOLANT 6-9

ANTI-FREEZE..... 6-9

CHECKING AND ADDING FUEL 6-10

CHECKING BATTERY 6-10

CHECKING HOSES AND PIPES..... 6-11

CHECKING ELECTRIC WIRING..... 6-11

GREASING 6-12

CHECKING AND ADJUSTING STEERING WHEEL..... 6-12

CHECKING AND ADJUSTING BRAKE..... 6-12

CLEANING FUEL FILTER SEPARATOR..... 6-13

CHECKING EXHAUST GAS..... 6-14

CHECKING FUSE AND FUSIBLE LINK..... 6-14

CHECKING AND ADJUSTING TOE-IN 6-15

CH ECKING AND ADJUSTING FAN BELT..... 6-15

Designed for your world



6-2 Designed for your world

MAINTENANCE SCHEDULE CHART

- ※ Check or adjust each part only when the engine is stopped.
- ※ When any hot part should be serviced, wait until it is cooled down.
- ※ Prioritize the interval of hour or year whichever it comes first.

- : Adjust · Check
- : Replace
- △ : Clean
- ★ : First time only
(Replace/Clean/Check)

PART	ITEM	INTERVAL - HOUR											YEAR		REMARK	
		EVERY 50	EVERY 100	EVERY 150	EVERY 200	EVERY 250	EVERY 300	EVERY 350	EVERY 400	EVERY 450	EVERY 500	EVERY 2,000	EVERY 1	EVERY 2		
ENGINE	COOLANT LEVEL	CHECK BEFORE EVERY WORK														
	COOLANT														●	
	ENGINE OIL LEVEL	CHECK BEFORE EVERY WORK														
	ENGINE OIL & FILTER	★				●										
	FUEL FILTER											●				
	AIR CLEANER ELEMENT		△									●				
	RADIATOR & NET	CHECK BEFORE EVERY CLEAN														
	RADIATOR INSIDE	CLEAN WHEN COOLANT IS REPLACED														
	FAN BELT & AIR CONDITIONER BELT		○													REPLACE WHEN IT IS NEEDED
BATTERY		○													REPLACE/CHARGE WHEN IT IS NEEDED	
HOSS & BANDS	FUEL HOSE & BAND										○			●	REPLACE WHEN IT IS DAMAGED	
	AIR CLEANER HOSE & BAND										○			●		
	INLET HOSE & BAND										○			●		
	RADIATOR HOSE & BAND										○			●		



○ : Adjust · Check △ : Clean
 ● : Replace ★ : First time only
 (Replace/Clean/Check)

PART	ITEM	INTERVAL - HOUR											YEAR		REMARK	
		EVERY 50	EVERY 100	EVERY 150	EVERY 200	EVERY 250	EVERY 300	EVERY 350	EVERY 400	EVERY 450	EVERY 500	EVERY 2,000	EVERY 1	EVERY 2		
T/M	TRANSMISSION OIL	★			●											FIRST 50 HR REPLACE
	HST OIL FILTER	★							●							
	SUCTION FILTER	★			●											
OTHERS	FRONT AXLE OIL	★			●											
	BOLTS & NUTS	CHECK BEFORE EVERY WORK														
	BRAKE PEDAL FREE PLAY	CHECK BEFORE EVERY WORK														
	FRONT REAR WHEEL	CHECK BEFORE EVERY WORK														
	GREASING EACH PART	○														GREASING WHEN EVERY WATERY WORK
	THROTTLE SYSTEM							○								
	ELECTRIC WIRING	○														REPLACE WHEN IT IS DAMAGED
	TOE-IN							○								GET SERVICED AT WORKSHOP

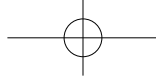

FLUIDS FLUIDS AND CAPACITY

No.	ITEM	Capacity (ℓ)	Specification	Remarks
1	Fuel	27.0	Diesel fuel (KS2)	For summer: S, For winter: W
2	Engine oil	4.3	SAE 15W-40	CJ grade or higher
3	Grease	As needed	KSM2130 NO.2	Multi purpose type
4	Coolant	6.6	Appropriate genuine anti-freeze	NO.2 of KSM2142 or equivalent, permanent type
5	Transmission oil (Also for hydraulic steering wheel)	37.0	TF500 (SAE 80W90)	TEXCO TDHOIL, 1893 CHEVRON tractor hydraulic fluid
6	Front axle	7.0	GL-4 (SAE 80W90)	

 **WARNING**

- Check the oil level regularly. Correct the oil level, if needed, before operating.
- Always check and add oil with the tractor on a flat, level surface.

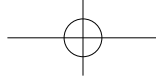

ROUTINE MAINTENANCE OPENING HOOD

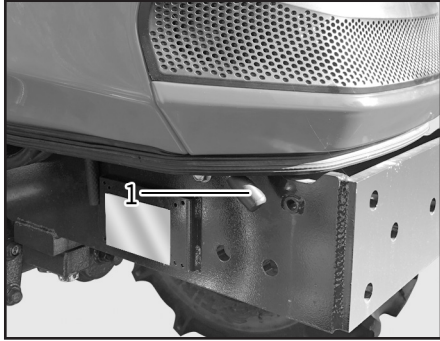

(1) Opening Lever

1. The hood can be unlocked by pulling the opening lever.
2. Slightly lift the hood with both hands and the hood is automatically lifted by the gas spring.
3. To close the hood, press its front down slightly until a “click” sound is heard.
4. After closing the hood, lift it to check that the hood is securely fixed.

CHECKING AND REPLACING ENGINE OIL

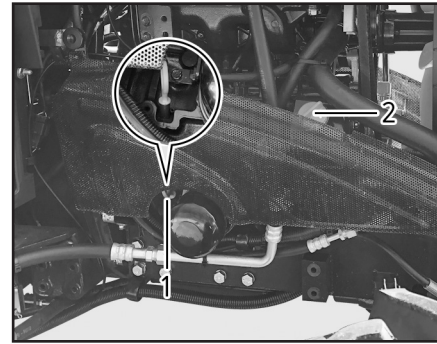

(1) Oil Dipstick

(2) Oil Inlet

Pull out the oil dipstick, clean it, and then insert it into its original position. Then, pull it out again and check if the oil level is within the specified range. If the oil level is too low, add new oil so that the level is within the allowable range.

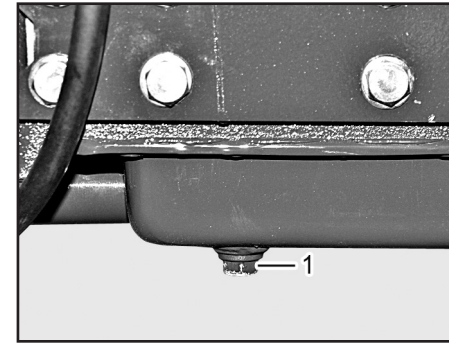

(1) Drain Plug

To drain oil, remove the drain plug on the bottom of the engine. Fill new engine oil through the filler after installing the drain plug. Change engine oil periodically with proper engine oil according to the temperature and operating condition.

NOTE

- First 50HR engine oil has to be changed.

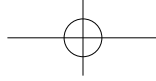

CHECKING AND CHANGING TRANSMISSION FLUID

▶CHECKING

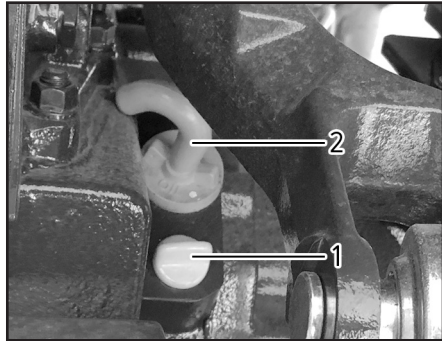

(1) Oil Dipstick (2) Oil Inlet

Pull out the oil dipstick from the top of the rear axle housing on the left. Then, wipe it end clean, insert it into the housing, and pull it out again to check if the oil level is between the upper and lower limit marks. If the oil level is too low, add some new oil so that the level is within the allowable range. Also, check for leakage.

▶CHANGING

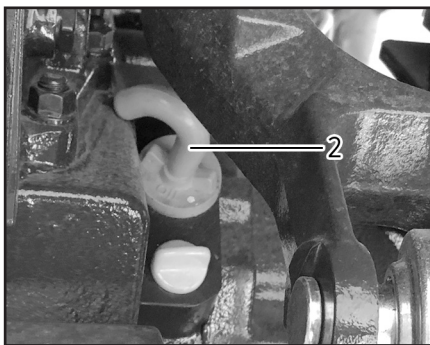

(1) Rear Axle Case Drain Plug
(2) Oil Inlet

Drain transmission fluid by removing the drain plug from the transmission or rear axle case. Change transmission fluid periodically with proper one according to the temperature and operating condition.

! DANGER

- Be sure to turn “OFF” the main (ignition) key switch to stop the engine before pulling out the oil dipstick.

! CAUTION

- Drain oil while it is warm. However, if it is excessively hot, be careful of a burn.

NOTE

- First 50HR transmission fluid has to be changed.



CHECKING AND CHANGING FRONT AXLE OIL

▶CHECKING

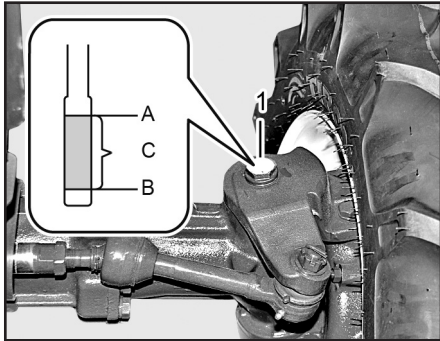

(1) Oil Dipstick
 (A) Upper Limit (B) Lower Limit
 (C) Specified Level

Unscrew the oil filler plugs on the left sides of the front axle housing, wipe them clean, and then insert them into their original position. Then, pull them out again and check if the oil level is within the specified range. If the oil level is too low, add some new oil so that the level is within the allowable range. Also, check for leakage.

▶CHANGING

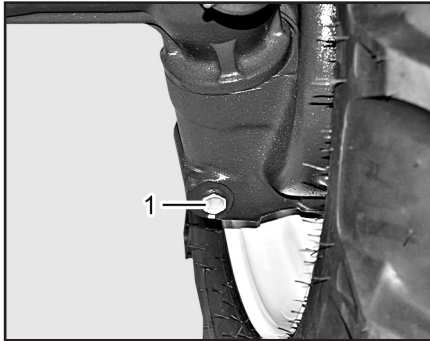

(1) Drain Plug

To drain the used oil, remove the right and left drain plugs under the front axle and drain the oil completely.

NOTE

- **First 50HR front axle oil has to be changed.**

REPLACING ENGINE OIL FILTER

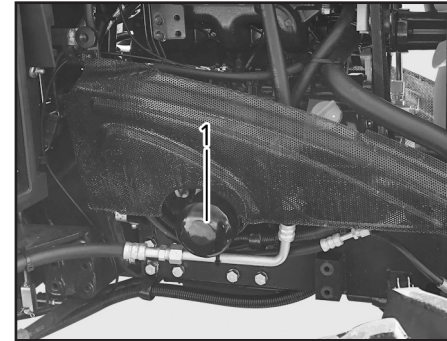

(1) Oil filter cartridge

1. After draining engine oil, remove the oil filter cartridge by turning it counter-clockwise with a filter wrench.
2. Apply a thin film of oil to the rubber ring on the bottom of a new filter and securely install it.
3. After changing engine oil, start and run the engine until the hydraulic pilot lamp is turned off.

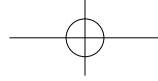

4. Check the engine oil level again with the oil dipstick after the hydraulic pilot lamp is turned off. If the level is low, add more oil.
5. This filter is a cartridge type. Replace it at every 250 hours of operation.

NOTE

- First 50HR engine oil filter has to be changed.

REPLACING TRANSMISSION OIL FILTER

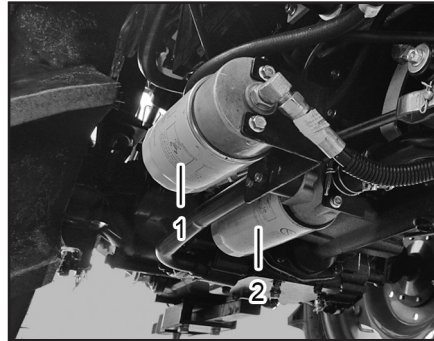

- (1) HST Filter Cartridge
(2) Oil Filter Cartridge

1. After draining transmission oil, remove the oil filter cartridge by turning it counterclockwise.
2. Apply a thin film of oil to the rubber ring on the bottom of a new filter and securely install it.
3. After changing transmission oil, run the engine to deliver oil to each part, and then stop the engine.
4. Check the transmission oil level again with the oil dipstick. If the level is low,

add more oil.

5. This filter is a cartridge type. Replace it at every 300 hours of operation.

NOTE

- First 50HR transmission fluid filter has to be changed.

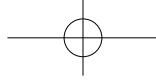

CHECKING AND CHANGING COOLANT

▶CHECKING

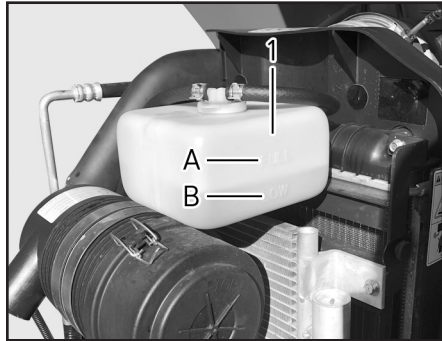

(1) Coolant Reservoir Tank
(A) FULL (B) LOW

Open the hood and check if the coolant level in the reservoir tank is between the “FULL” and “LOW” marks. Add coolant through the filler if necessary.

▶REPLACEMENT PROCEDURE

1. To drain coolant, open the radiator cap and drain plug and drain coolant completely from the radiator.
2. Flush the radiator until clean water is drained.
3. Add coolant up to the filler neck of the radiator.
4. Start and operate the engine for 5 minutes after filling the reservoir tank with coolant up to the “FULL” level. At this time, press the heater switch of the air conditioner to activate the heater. Stop the engine and check if the coolant level is between the “FULL” and “LOW” marks. If not, add some coolant as needed.

CHECKING AND ADDING FUEL

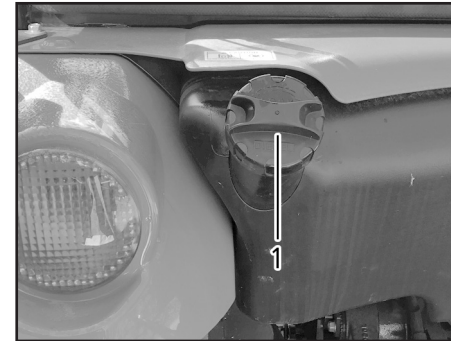

(1) Fuel cap

Turn the main switch to the “ON” position. If the fuel gauge needle is pointing the red area, open the fuel cap, and then fill the fuel tank full through the oil filler. And check if there is leakage.

6

DANGER

- Never smoke or use a lighter while refueling the tractor.
- After refueling, securely close the fuel cap and wipe off any spilled fuel.

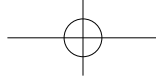

CHECKING BATTERY

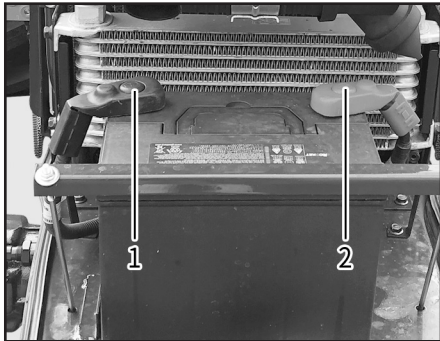

- (1) Ground Cable (-)
(2) Thick Red Wire (+)

Check if the electrolyte level is within the specified range and add distilled water up to the upper limit if necessary.

DANGER

- Do not expose the battery to flames or sparks.

If this instruction is ignored, you can get burnt by battery explosion.

CAUTION

- To connect the battery, connect its positive (+) cable first. To disconnect the battery, disconnect its negative (-) cable first.
- If the amount of electrolyte is excessive in each cell during charging the battery, the metal part of the tractor can be corroded due to the spilled electrolyte.
- Avoid boost charging as possible.
- Charge the battery after removing it from the tractor.
- When replacing the battery, use the TYM genuine battery.

CHECKING HOSES AND PIPES

Check the fuel hose, hydraulic steering wheel hose (pipe), radiator hose, etc. for damage or leakage. Check if there is any loose bolt. Replace the hoses and pipes every 2 years even if not damaged.

DANGER

- Make sure that fuel does not leak through the damaged fuel hose.

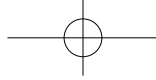

CHECKING ELECTRIC WIRING

Open the hood and check if any cable is in contact with other parts, or if any insulation is peeled off or damaged, or if any contact is loose. Damaged cables must be repaired by an authorized dealer. Arrange for periodic maintenance for cables every 50 hours or once a year even though the cables are not damaged.

DANGER

- Before starting to work every day, check if any cable is in contact with other parts, or if any insulation is peeled off or damaged, or any contact is loosened.
- Before and after work, remove any straw or dust on the battery or cables.

GREASING

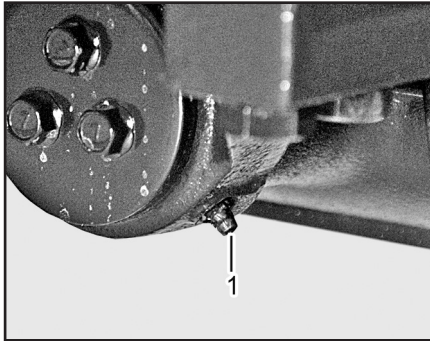

(1) Nipple

Apply grease every 50 hours. Check the relevant parts (9 points) before starting work everyday and add grease as necessary.

► GREASING POINTS

- Axle bracket (front & rear)
- Axle tie rod end (LH/RH)
- Brake pedals
- Lift rod (upper/lower)

After working in wet conditions, make sure to apply grease to the tractor.

CHECKING AND ADJUSTING STEERING WHEEL

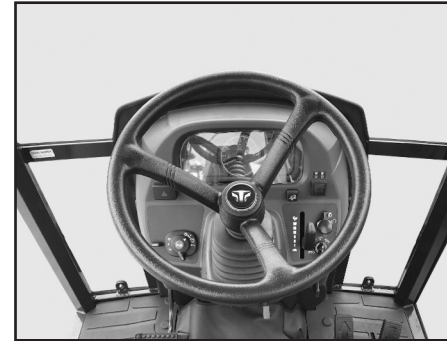

(A) Free Play Of Steering Wheel

When the steering wheel is turned to the left and right lightly, there should be free play for 0.8 - 2.0 in. (20 - 50 mm). If the extent of the free play exceeds this range, the steering wheel may feel heavy or the tractor may not move straight. If the free play is not normal, have it fixed at your nearest authorized dealer.

WARNING

- Check if the steering wheel vibrates severely or has no free play.

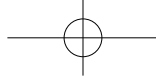

CHECKING AND ADJUSTING BRAKE

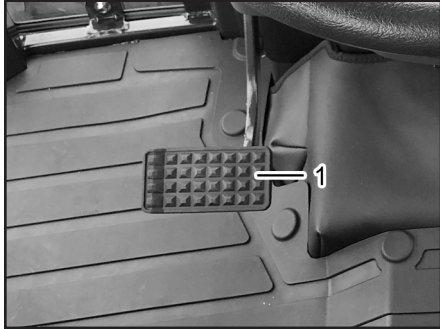

(1) Brake pedal (free play: 5 - 10 mm)

The free play of the brake pedal is 5 - 10 mm. Adjust both brake pedals at the same time.

CLEANING FUEL FILTER SEPARATOR

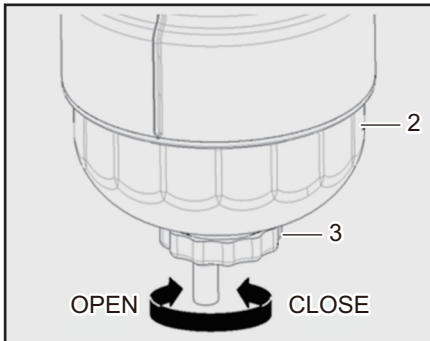
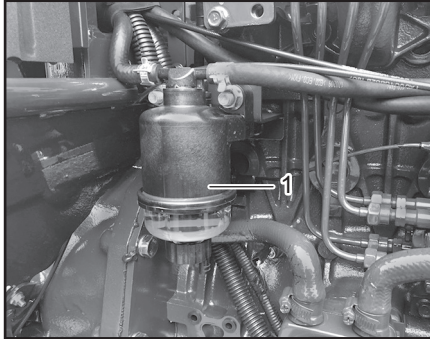

(1) Fuel Filter
(3) Drain Plug

(2) Filter Head

If moisture is found in the filter head(2), remove the foreign matter as follows.

- (1) Turn off the starter to prevent air from entering the fuel system.
- (2) Prepare a container to receive the water separator.
- (3) Loosen the drain plug(3) at the bottom of the filter head counterclockwise and let the water drain.
- (4) After the proper amount of fuel has been drained, manually lock the drain valve in the clockwise direction.
- (5) Do not use tools etc. at this time.

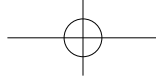

CHECKING EXHAUST GAS

Exhaust gas may be a little black at the time of starting the engine, but normally it is colorless.

- **Black:** Incomplete combustion due to too much fuel intake
- **White:** Burning of engine oil

If the temperature is low, water vapor may look white.

If the color of the exhaust gas remains black or white during operation, have the tractor inspected at your nearest authorized dealer.

CHECKING FUSE AND FUSIBLE LINK

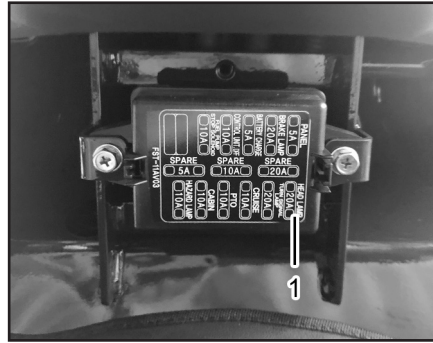

(1) Fuse Box

When replacing the fuse, use only the one with the specified capacity. Open the fuse box cover and check the fuses. Replace any blown fuses with new ones of required capacity. Stop the engine and check the main fuses (Fusible link).

If it is blown again, have the tractor inspected at the authorized dealer.



CAUTION

- When replacing the fuse, use only the one of the specified capacity.

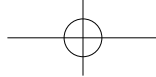

6-14 Designed for your world

CHECKING AND ADJUSTING TOE-IN

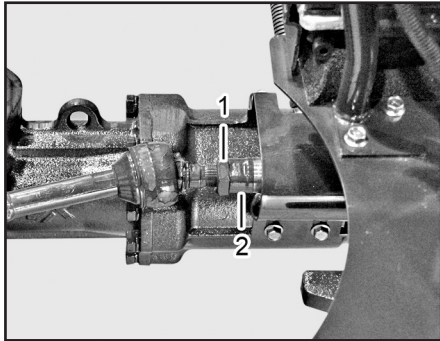

(1) Mounting Nut (2) Cylinder Rod

If the toe-in is not properly aligned, the steering wheel may be uncontrollable or the tractor may produce an abnormal vibration.

Measure the distance A and the distance B of the front wheels and see if the front one is narrower than rear one by 0.2 - 0.3 in. (4 - 8 mm)

If not, loosen the mounting nuts at the end of the cylinder rod on both sides and adjust the length of the screws.

Tighten the nuts when the toe-in is 0.2 - 0.3 in. (4 - 8 mm) Be sure of both lengths of the left and right tie rod ends are the same.

CHECKING AND ADJUSTING FAN BELT

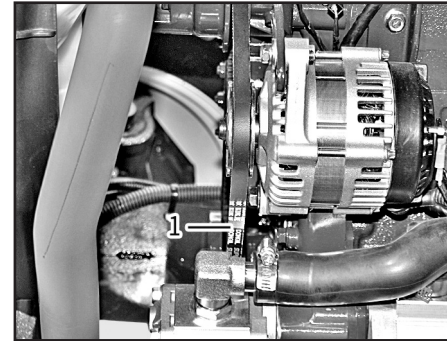

(1) Fan Belt

Loosen the generator mounting bolts and move the generator to adjust the tension of the fan belt.

If the fan belt still slips after the generator is moved to the maximum, replace the belt with a new one.

New belts must be inspected after 50 hours of running.

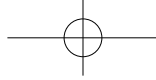

 **CAUTION**

- Carry out inspection or maintenance after the engine is fully cooled down. If this instruction is ignored, you may get burnt.



MEMO

A large, empty rectangular area with rounded corners, defined by a thin gray border, intended for writing a memo.

Designed for your world

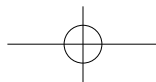

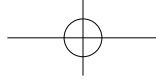

7. TROUBLESHOOTING

TROUBLESHOOTING - ENGINE..... 7-2

TROUBLESHOOTING - BRAKE 7-5

TROUBLESHOOTING - HYDRAULIC SYSTEM 7-6

TROUBLESHOOTING - ELECTRICAL SYSTEM 7-7





TROUBLESHOOTING - ENGINE

Symptom	Inspection item	Action
1. The starter motor does not start when the ignition switch is turned to "START".	• Is the battery discharged?	• Charge the battery.
	• Is the battery terminal loosened or corroded?	• Clean and tighten the terminals.
	• Is the main fuse blown out?	• Replace the fuse.
	• Is the ignition switch broken?	• Contact the dealer for repair or replacement.
	• Is the starter motor damaged?	• Contact the dealer for repair or replacement.
2. The starter motor runs, but the engine does not start.	• Is the fuel tank empty?	• Fill up the fuel tank and bleed the system.
	• Is the fuel mixed with air?	• Bleed the fuel system.
3. The engine revolution is irregular.	• Is air mixed in the fuel system?	• Bleed the fuel system.
	• Is water mixed in the fuel?	• Drain water and replace fuel.
	• Is the injection nozzle clogged?	• Contact the dealer for repair or replacement.
	• Is the fuel filter clogged?	• Clean or replace it.

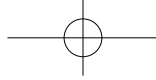

Symptom	Inspection item	Action
4. The engine is over-heated.	• Is the coolant level low?	• Refill the coolant.
	• Is the fan belt loosened or damaged?	• Adjust the belt tension or replace it.
	• Is the radiator fin clogged?	• Clean it.
	• Is the engine oil level low?	• Refill the engine oil.
	• Is the engine running under overload?	• Reduce the load.
5. The engine power is too weak.	• Is the air cleaner clogged?	• Inspect the air cleaner and replace the element.
	• Is the nozzle damaged?	• Contact the dealer for repair.
	• Is the compression force weak?	• Contact the dealer for repair.
	• Is the valve clearance adjusted properly?	• Contact the dealer for repair.
	• Is the injection timing incorrect?	• Contact the dealer for repair.

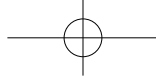

7-4 Designed for your world

Symptom	Inspection item	Action
6. The coolant warning lamp is turned "ON" during operation.	<ul style="list-style-type: none"> Is the coolant level in the reservoir tank low? 	<ul style="list-style-type: none"> Refill the coolant.
7. The engine oil pressure lamp is turned "ON" during operation.	<ul style="list-style-type: none"> Is the engine oil level low? 	<ul style="list-style-type: none"> Refill the engine oil up to required level.
	<ul style="list-style-type: none"> Is the viscosity of the engine oil low? 	<ul style="list-style-type: none"> Replace the engine oil with proper viscosity.
	<ul style="list-style-type: none"> Is the pressure switch defective? 	<ul style="list-style-type: none"> Replace the switch.
	<ul style="list-style-type: none"> Is the oil pump defective? 	<ul style="list-style-type: none"> Contact the dealer for repair.
8. The battery charge warning lamp is turned "ON" during operation.	<ul style="list-style-type: none"> Is the alternator defective? 	<ul style="list-style-type: none"> Contact the dealer for repair.
	<ul style="list-style-type: none"> Is the fan belt loosened or damaged? 	<ul style="list-style-type: none"> Adjust the fan belt tension or replace it.

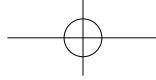
**TROUBLESHOOTING - BRAKE**

Symptom	Inspection item	Action
1. The brake does not work or works only on one side.	<ul style="list-style-type: none">• Is the free play of the brake pedals proper?	<ul style="list-style-type: none">• Adjust the free play of the pedals.
2. The brake pedal does not return to its original position properly and it makes a noise.	<ul style="list-style-type: none">• Is the brake pedal return spring damaged?	<ul style="list-style-type: none">• Replace the spring.
	<ul style="list-style-type: none">• Is each sliding part well greased?	<ul style="list-style-type: none">• Remove the rust and apply grease.

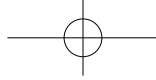

TROUBLESHOOTING - HYDRAULIC SYSTEM

Symptom	Inspection item	Action
1. The implement does not be lifted.	• Is the hydraulic flow control dial in the close position?	• Adjust the hydraulic flow control dial.
	• Is the transmission oil level low?	• Refill the transmission oil.
	• Is the air taken in the fluid suction system?	• Tighten the filter or connection parts. Replace the pipe or O-ring if damaged.
	• Is the oil filter clogged?	• Clean or replace it.
	• Is the Selective control valve lever in the detent position?	• Put the Selective control valve lever in the neutral position.
	• Is the hydraulic pump defective?	• Contact the dealer for repair.
	• Is the cylinder damaged?	• Contact the dealer for repair.
2. The implement does not be lowered.	• Is the hydraulic flow control dial in the close position?	• Adjust the hydraulic flow control dial.
	• Is the position control lever on the lowest position?	• Move the position control lever.
	• The implement cannot be lowered even though the position control lever is placed in the lowest position.	• Contact the dealer for repair.

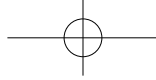
**TROUBLESHOOTING - ELECTRIC SYSTEM**

Symptom	Inspection item	Action
1. The headlamp does not turn "ON".	• Is the bulb blown?	• Replace the bulb.
	• Is the fuse blown?	• Replace the fuse.
	• Is the cable connector separated from the socket?	• Inspect it.
	• Is the contact in a poor condition?	• Inspect and clean the grounding and terminals.
2. The turn signal lamp does not come "ON".	• Is the bulb blown?	• Replace the bulb.
	• Is the fuse blown?	• Replace the fuse.
	• Is the cable connector separated from the socket?	• Inspect it.
	• Is the contact in a poor condition?	• Inspect and clean the grounding and terminals.
3. The other lamp does not turn "ON".	• Is the bulb blown?	• Replace the bulb.
	• Is the fuse blown?	• Replace the fuse.
	• Is the cable in a poor contact?	• Inspect the cable and secure the contact.
	• Is the switch defective?	• Replace the switch.



MEMO

A large, empty rectangular area with rounded corners, defined by a thin gray border, intended for writing a memo.

Designed for your world

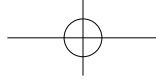

8. STORAGE AND DISPOSAL

DAILY STORAGE8-2

LONG-TERM STORAGE.....8-3

OPERATING TRACTOR AFTER LONG-TERM STORAGE8-6

USAGE AND DISPOSAL8-7

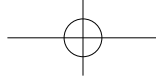

DAILY STORAGE

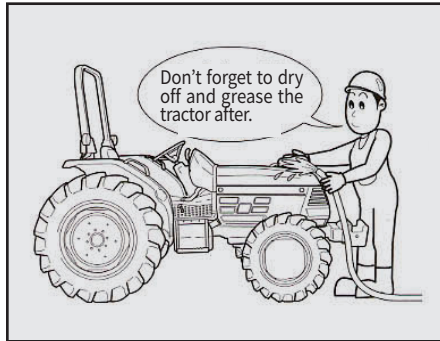

After work, clean the tractor and dry the moisture and supply grease into each grease nipple.

Avoid water on electrical parts whenever possible, as it will cause equipment breakdown.

1. Store the tractor after cleaning it. Especially, clean it thoroughly after harrowing or working in a wet field.
2. Be sure to lower the implement.
3. Store it indoors if possible. If it should be kept outside, cover it.

CAUTION

- Unless the battery is removed from the vehicle, make sure to disconnect the negative(-) battery cable. The wiring can be gnawed by rodents, leading to a fire.

4. Remove the battery from the tractor in winter and store it indoors for easy starting.
5. Add anti-freeze to the tractor in winter season in order to prevent the radiator from freezing.
6. Remove the ignition key and store it separately.

DANGER

- When covering the tractor, make sure that the engine or the muffler has fully cooled down.

[Otherwise]

There is a risk of fire.

CAUTION

- When carrying out checking, maintenance, or repair, make sure to turn off the engine.

[Otherwise]

There is a risk that you may be entangled in the tractor or get injured.

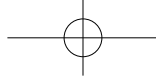

LONG-TERM STORAGE

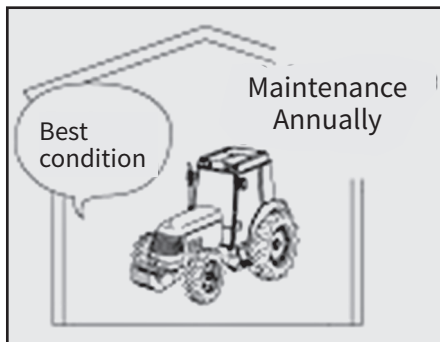

In particular, we recommend that the electrical cables and the rubber hoses, such as fuel hose, steering hoses and radiator hoses, be replaced every two years.

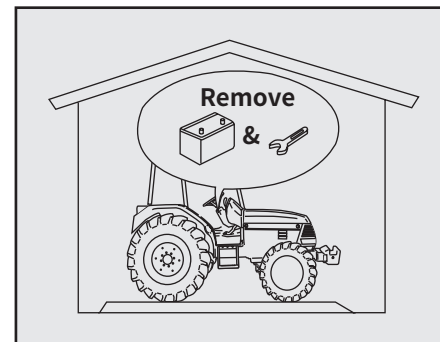

If you carry out maintenance during the off season, you can ensure optimum condition of the tractor as well as safe and comfortable working conditions during the busy season. Also, in order to secure the safety of each part of the tractor and to prevent an accident that may occur due to poor maintenance, arrange with your authorized dealer for periodic maintenance once a year.

If the tractor is not used for a long time, store it in the following manner.

1. For long storage, put the ignition switch to “OFF”.
2. Select a dry and well-drained place for storage. Remove detach the weight & implement or put it down onto the ground.

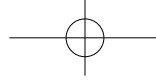

8-4 Designed for your world

3. Fill up the fuel tank. Empty space in the fuel tank will produce dewdrops that will produce condensation that will be the cause of rust formation. And lock the fuel cock to “C”. (Closed)
4. Disconnect the battery completely and store it away from the tractor in a well-ventilated, dry, dark place if possible. When the battery is attached to the tractor, make sure to connect the (+) terminal first.
5. Change the engine oil and run the engine to circulate oil throughout all the engine parts for about 5 minutes.
6. Drain the coolant from the radiator. After draining the coolant, attach a tag of "No coolant, do not start" to the steering wheel. If there is anti-freeze in the cooling system, it is not necessary to drain it.
7. Check the bolts and nuts for looseness, and tighten if necessary.
8. Add oil, fluid and fuel to each part according to the maintenance chart.
9. Apply a slight coat of grease or oil onto the tractor parts where is easy to be rust such as bare metal surface.
10. Inflate the tires to a pressure a little higher than usual.
11. Place chocks behind and in front of the rear wheels.
12. Store it in a dry indoor place to avoid rain or snow and cover the body.
13. Put all controls into the neutral position.

IMPORTANT

- When cleaning the tractor, be sure to stop the engine. Allow sufficient time for the engine to cool before washing.
- Cover the tractor after the muffler and engine have cooled down completely.

WARNING

- Carry out maintenance on a flat and safe place where the tractor will not fall or move and there is no traffic danger. Also, block the front tires to prevent moving of the tractor. Otherwise, there is a risk of accident, such as overturning of the tractor.

**⚠ WARNING**

- Carry out checking and maintenance for each part every year.
- In particular, replace the fuel hoses and the steering hoses every two years. Otherwise, there is a risk of accident or machinery breakdown due to poor maintenance.
- When carrying out checking or maintenance, make sure to stop the engine.
- Replace the covers that have been defected for checking or maintenance.
- Carry out checking or maintenance after heated parts, such as muffler, engine or transmission, have fully cooled down. Otherwise, there is a risk of getting burnt.

⚠ CAUTION

To avoid a personal injury,

- Never clean the tractor body while the engine is running.
- Never run the engine in an enclosed area without proper ventilation system in order to prevent poisoning by exhaust gas.
- When storing the tractor, remove the key from the switch and store it separately in order to prevent an unauthorized person from operating the tractor and being injured.

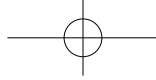

8-6 Designed for your world

OPERATING TRACTOR AFTER LONG-TERM STORAGE

Keep the following instructions when operating the tractor after its long-term storage.

1. Perform the inspection procedures before operation.
2. Check the tire air pressure and inflate the tires if it is low.
3. Install a fully charged battery. Check that the battery is fully charged before installing it.
4. Check the fan belt tension.
5. Check all fluid levels. (Engine oil, transmission/hydraulic oil, and engine coolant)
6. Remove grease from the exposed cylinder rod.
7. Apply grease to the lubrication points.
8. Remove the cover from the exhaust pipe.
9. Get onto the tractor and start the engine. To prolong the life and to enhance the performance of the engine, idle the engine for about 30 minutes before starting work.
10. Start the engine, release the parking brake, and check the brake condition by depressing the brake pedal. Adjust the free play of the brake pedals if necessary.
11. Check if the instrument panel and all parts operate correctly while running the engine for a few minutes.
12. Drive the tractor outside and check if it is operating properly. Park the tractor outside and idle the engine for at least 5 minutes. Stop the engine and visually inspect the tractor. Check if there is leakage.
13. Stop the engine and check for leakage. Repair any part as required.



WARNING

- When operating the tractor in an enclosed area, ventilate the area to release exhaust gas to the outside. Exhaust gas is colorless and not visible, but is harmful.

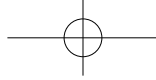

USAGE AND DISPOSAL

It is recommended to keep the following to protect the environment:

1. Overload on the machine shortens the product life and increases the harmful exhaust gas which causes air pollution due to the incomplete combustion.
2. When changing the fluid (engine oil, transmission/hydraulic oil, and engine coolant) by yourself, be careful not to spill it and dispose used oil and coolant properly according to the applicable regulations. Otherwise, it can pollute the ground and water.



MEMO

A large, empty rectangular area with rounded corners, defined by a thin gray border, intended for writing a memo.

Designed for your world

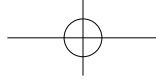

9. EMISSIONS CONTROL WARRANTY

EMISSIONS CONTROL WARRANTY9-2



EMISSIONS CONTROL WARRANTY

U.S. EPA EMISSIONS CONTROL WARRANTY STATEMENT YOUR WARRANTY RIGHTS AND OBLIGATIONS

In accordance with 40 CFR Part 1039, TYM is pleased to explain the emission control system warranty on your engine. In the US, new engines must be designed, built and equipped to meet the stringent anti-smog standards. TYM must warrant the emission control system on your engine for the periods of time listed below provided there has been no abuse, neglect or improper maintenance of your engine. Additional conditions and responsibilities are further outlined below. Where a warrantable condition exists, TYM will repair your engine at no cost to you including diagnosis, parts and labor.

MANUFACTURER'S WARRANTY COVERAGE:

TYM warrants to the original owner, and to each subsequent owner, of a new, diesel engine that the emission control system of your engine:

1. Was designed, built and equipped so as to conform at the time of sale with all applicable regulations.

2. Is free from defects in material and workmanship which will cause such engine to fail to conform with applicable regulations for the following warranty period:
- for variable speed engines rated under 19 kW (25 HP): two (2) years or 1,500 hours of operation, whichever occurs first. In the absence of a device to measure hours of use, the engine shall be warranted for a period of two years.
 - for constant speed engines rated under 37 kW (50 HP) with peak power rated at less than 3,000 RPM: five (5) years or 3,000 hours of operation, whichever occurs first. In the absence of a device to measure hours of use, the engine shall be warranted for a period of two years.
 - for engines rated at or above 19 kW (25 HP): five (5) years or 3,000 hours of operation, whichever occurs first. In the absence of a device to measure hours of use, the engine shall be warranted for a period of five years.

The warranty period shall begin when the engine is placed into service.

OWNER'S WARRANTY RESPONSIBILITIES:

- This engine is designed to operate on diesel fuel only. Use of any other fuel may result in the engine no longer operating in compliance with EPA's applicable emissions requirements.
- The purchaser is responsible for initiating the warranty process. You must present the engine to a TYM dealer as soon as a problem exists.

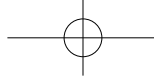

9-4 Designed for your world

- The use of any non-exempted add-on or modified parts shall be grounds for disallowing a warranty claim. TYM is not liable for failures of warranted parts caused by the use of a non-exempted add-on or modified part.
- The purchaser is responsible for the performance of all scheduled maintenance or repairs on this new TYM engine. TYM may deny a warranty claim if failure to perform maintenance results in the failure of a warranted part. Receipts covering the performance of regular maintenance should be retained in the event of questions arise concerning maintenance. The receipts should be transferred to each subsequent owner of the equipment with the emission warranted engines.

EMISSIONS WARRANTY EXCLUSIONS:

- Malfunctions in any part caused by misuse, abuse, improper adjustments, modifications, alteration, tampering, disconnection, improper or inadequate maintenance, or use of fuels not recommended for the engine as described in the Maintenance Manual.
- Damage resulting from accident, acts of nature or other events beyond the control of TYM.
- Loss of time, inconvenience, loss of use of equipment, engine or commercial loss.



EMISSION PARTS COVERED UNDER WARRANTY:

The following is a list of emission control parts that are covered by the Limited Emission Control System Warranty. This warranty covers include any engine parts related to the following systems:

- Fuel Injection Pump
- Fuel Injectors
- Ignition system
- Intake Manifold
- Electronic control units (if equipped)
- Sensors (if equipped)
- Exhaust Manifold
- Positive Crankcase Ventilation system parts (including PCV Valve and Oil Filler Cap)
- Turbocharger (if equipped)
- Charge air cooling system (if equipped)
- Smoke puff limiter (if equipped)
- EGR (if equipped)
- Air-induction system (e.g., intake and exhaust manifolds).
- Aftertreatment devices, if equipped (e.g., Diesel Particulate Filter [DPF], Diesel Oxidation Catalyst [DOC]).

Miscellaneous hoses, clamps, connectors and sealing gaskets or devices used in the above systems.

Emission-related components also include any other part whose only purpose is to reduce emissions or whose failure will increase emissions without significantly degrading engine/equipment performance.

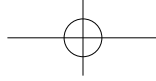

MEMO

A large, empty rectangular area with rounded corners, defined by a thin gray border, intended for writing a memo.

Designed for your world

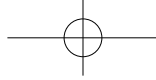

T3025 (CH)

OPERATOR'S MANUAL FOR TYM TRACTORS

⚠ ALL INFORMATION, ILLUSTRATIONS AND SPECIFICATIONS IN THIS MANUAL ARE BASED ON LATEST INFORMATION AVAILABLE AT THE TIME OF PUBLICATION. THE RIGHT IS RESERVED TO MAKE CHANGES AT ANY TIME WITHOUT A NOTICE.

241226

PART NO.

